

(Cover page)

HEALING OF THE ACUTE AND CHRONIC EXPERIMENTAL TRYPANOSOMIASIS  
BY THE COMBINED ACTION  
OF MODULATED MAGNETIC FIELDS AND ELECTROMAGNETIC WAVES

A. PRIORE

(Submitted to Bordeaux University, France, in 1974.  
Translated from French

(inside page)

To struggle to convince yourself  
of the truth that you have glimpsed,  
is the first step toward progress ....

To persuade the others is the second ....

There is a third one,  
maybe less useful, but very  
enviable nonetheless,  
which is to convince your adversaries! ....

Louis Pasteur

(New page)

## TABLE OF CONTENT

	<u>Pages</u>
INTRODUCTION	1
CHAPTER I: EQUIPMENT AND METHODS	5
1. STUDY OF THE EMITTED RADIATION	5
I. The Plasma	
II. The UHF wave	
III. The HF Wave	
IV. The Magnetic Field	
2. THE PARASITES	8
2.1. Trypanosomes	
2.1.1. Trypanosoma equiperdum	
a. The pathogenic agent	
b. Antigenic variation	
2.1.2. Trypanosoma gambiense	
2.2. Hematozoa	11
3. THE HOST ANIMALS	13
4. THE PARASITIC MODELS	14
4.1. Acute Trypanosomiasis with T. Equiperdum	14
4.1.1. Characteristic of the disease	
4.1.2. Antigenic variation	
4.2. Chronic trypanosomiasis	16
4.2.1. Experimental Trypanosomiasis of rabbit with T. Equiperdum	
a. Evolution of disease	
b. Histological study of the testicular lesions	
c. Antigenic variation	
4.2.2. Experimental Trypanosomiasis of the mouse with T. Gambiense	
4.3. Paludism of the mouse with P. Berghei	20
5. METHOD OF STUDY OF HOST ANIMALS EXPERIMENTALLY INFESTED (IRRADIATED AND NON-IRRADIATED)	21
5.1. Clinical observation	21
5.2. Parasitemia - Negativation	21
5.2.1. Acute Trypanosomiasis of the mouse and of rat with T. Equiperdum	
5.2.2. Chronic Trypanosomiasis of rabbit with T. Equiperdum	
5.2.3. Chronic Trypanosomiasis of the mouse with T. gambiense	
5.2.4. Paludism of the mouse with P. Berghei	
5.3. Study of the immune status	23
5.3.1. Serous levels of G and M immunoglobulins (IgG and IgM)	
a. Dosage technique of the G and M immunoglobulins	

b.	Evolution of G and M immunoglobulins during acute trypanosomiasis of the mouse and rat with <i>T. Equiperdum</i>	
c.	Evolution of G and M immunoglobulins during the chronic trypanosomiasis of rabbit with <i>T. Equiperdum</i>	
d.	Evolution of the G and M immunoglobulins during the chronic trypanosomiasis of the mouse with <i>T. Gambiense</i> .	
5.3.2.	State of immune protection	
5.3.3.	Study of certain humoral antibodies	
a.	(General) antigenic structures of <i>T. Equiperdum</i>	
b.	Agglutinants antibodies	
c.	Hemagglutinants antibodies	
d.	Precipitants antibodies	
e.	Sero-protective antibodies	
f.	Evolution of humoral antibodies during the acute trypanosomiasis of the mouse and rat with <i>T. Equiperdum</i>	
g.	Evolution of humoral antibodies during the chronic trypanosomiasis with <i>T. Equiperdum</i>	
5.4.	Criteria of parasitological healing	32
5.4.1.	Experimental Trypanosomiasis due to <i>T. Equiperdum</i>	
5.4.2.	Chronic trypanosomiasis of the mouse with <i>T. Gambiense</i>	
 CHAPTER II: RESULTS		 33
1.	THE FIRST IRRADIATION EXPERIMENTS	34
1.1.	Irradiation experiments with device No 1. HF wavelength of 19 m: experiments A HF wavelength of 17 m: experiments B	34
1.2.	Irradiation experiments with device No 2: experiments C	34
2.	ACUTE TRYPANOSOMIASIS WITH <u><i>T. EQUIPERDUM</i></u> : TUNING OF EXPERIMENTAL CONDITIONS LINKED TO THE PARASITIC MODEL	40
2.1.	Duration of the daily irradiation: experiments D	40
2.2.	Importance of the inoculum: experiments E	40
2.3.	Importance of the time of the start of treatment: experiments F	41
2.4.	Influence of preliminary splenectomy: experiments G	42
2.5.	Behavior of the dyskinetoplastic strain (Bethesda) of <i>Trypanosoma equiperdum</i> : Experiments H	42
2.6.	Influence of the total duration of treatment: experiments I (Number of irradiation sessions)	43
2.7.	Results obtained in the rat: experiments J	44
2.8.	Body temperature of mice treated by the radiation	44

3.	ACUTE TRYPANOSOMIASIS WITH <u>T. EQUIPERDUM</u> : TUNING OF EXPERIMENTAL CONDITIONS LINKED TO RADIATION	46
3.1.	Influence of the distance relative to the output face of the plasma tube: experiments K	46
3.2.	Influence of the distance relative to the axis of the plasma tube: experiments L and M	47
3.3.	Synergy of the essential constituents of the radiation: experiments N, O, P and Q	51
3.4.	Influence of the nature of the magnetron: experiments R	52
3.5.	Effect of accessory constituents of the radiation: experiments S	52
4.	MICE AND RATS INFESTED WITH <u>T. EQUIPERDUM</u> : STUDY OF THE IMMUNE STATUS OBTAINED WITH THE HELP OF TREATMENT BY IRRADIATION	54
4.1.	Serous levels of the IgG and the IgM	54
4.2.	Evolution of the humoral antibodies	54
4.3.	Study of the state of immune protection - Reinfestation	55
4.3.1.	Mice having presented fatal relapses	
4.3.2.	Mice having evolved toward the healing but after a parasitemic moderate and temporary relapse.	
4.3.3.	Mice having evolved directly toward healing: experiments T and U	
4.3.4.	State of immune protection in the rats infested by T. Equiperdum and treated by the radiation: experiments V. Phenomena of therapeutic facilitation: experiment W.	
5.	CHRONIC TRYPANOSOMIASIS OF RABBIT WITH <u>T. EQUIPERDUM</u> EFFECT OF RADIATION	61
5.1.	Effect of the treatment by irradiation started 2 hours after infestation: experiment X	61
5.2.	Effect of treatment by irradiation started after a certain time of evolution of the disease.	63
5.2.1.	Evolution of the disease for 2 weeks: experiment Y	
5.2.2.	Evolution of the diseases for 3 weeks: experiment Z	
5.2.3.	Evolution of the disease for 4 weeks: experiment AA	
5.3.	Histological study of the testicular lesions and of their evolution in rabbits treated by irradiation.	65
5.3.1.	Treatment started 2 hours after the infestation	
5.3.2.	Treatment started after two weeks of evolution of the disease	
5.4.	Body temperature of rabbits during the treatment	67
5.5.	Trypanosomed rabbits healed by the radiation: effect of a reinfestation not accompanied by irradiation (experiment AB)	68
5.6.	Trypanosomed rabbits healed by the radiation: effect of reinfestations accompanied by irradiations (experiment AC)	68
5.7.	Analysis of the sero-protective power: confirmation of its immunoglobulinic nature (experiment AD)	71

6. CHRONIC TRYPANOSOMIASIS OF THE MOUSE WITH <u>T. GAMBIENSE</u> : EFFECT OF THE RADIATION (experiments AE and AF)	74
7. PALUDISM OF THE MOUSE WITH <u>P. BERGHEI</u> : EFFECT OF RADIATION (experiments AG)	77
CHAPTER III: DISCUSSION - CONCLUSION	78
1. GENERAL CONSIDERATIONS	78
1.1. Control of inoculated trypanosomes - Control animals	79
1.2. Control Board	79
1.3. Eventual existence of a thermal effect	80
1.4. The effect of the radiation is not always a total effect	80
1.4.1. Value of the HF wavelength	
1.4.2. Influence of the power of the UHF wave	
1.4.3. The notion of “superior limit of the biological effect of the radiation”.	
1.4.4. Mice infested with T. Equiperdum and placed under treatment after 48 hours of evolution of the acute trypanosomiasis	
1.4.5. Duration of treatment by irradiation	
1.4.6. Effect of the treatment by irradiation on the chronic trypanosomiasis of the mouse with T. Gambiense	
1.4.7. Effect of the radiation in other parasitic models	
2. MECHANISM OF OPERATION	84
2.1. Exclusive effect on the trypanosome	84
2.1.1. Propagation of the components of the radiation throughout the organism	
2.1.2. The notion of “superior limit of the biological effect of the radiation”	
2.1.3. The phenomenon of therapeutic facilitation	
2.1.4. Irradiation of the trypanosomes maintained alive “in vitro”	
2.2. Stimulation of defense mechanisms	86
2.2.1. Evolution of the parasitemia in the mice infested with T. Equiperdum and treated by irradiation	
2.2.2. Decrease of the parasitemia until the negativation between two seances of irradiation	
2.2.3. Influence of the UHF wave power	
2.2.4. Effect of the treatment by irradiation on the trypanosomiasis of the mouse with T. gambiense	
2.2.5. Propagation of the components of the radiation in the organism	
2.2.6. Phenomenon of therapeutic facilitation	
2.2.7. Mice infested with T. Equiperdum and treated after 48 hours of evolution of the disease	
2.2.8. Effect of the radiation in other parasitic models.	

2.3. Combination of the two previous mechanisms	91
3. CONCLUSION	92
RESUME	94
BIBLIOGRAPHY	101
FIGURES	109

(Unnumbered page)

## INTRODUCTION

(Page 1)

Over the last years, an increasing number of researchers from the most various fields, have become interested into the effects produced by magnetic fields or by electromagnetic waves on certain forms of life. This is not a new topic. Indeed, the study of the effect of magnetic fields on living matter goes back to many years ago. The first paper that we will quote is the publication by D'Arsonval in 1882 about "The effect of a strong magnetic field on the fermentations" (15). Then, D'Astre (16) also studies this phenomenon and publishes a paper on "Physiological influence of the magnetic state".

Other researchers carried their experimental works along the same lines, but it is only since the second World War that such studies have taken ever more importance (3, 5).

So, starting around 1958, J.M. Barnothy puts mice into a strong magnetic field and observes a slower growth in them (1). Moreover, in 1964, M.F. Barnothy (4) shows the effect of such magnetic fields on the rate of multiplication of blood leucocytes, and J.M. Barnothy (2) studies the effect of magnetic field on mice carrier of T-2146 tumors: their body immunity appears increased, the survival of animals appears increased but it is impossible to say if its effect has influences on the immunity of the host animal or on the tumorous cells.

On this problem, a paper by Gross and Smith (25) brings in some elements of information: the sojourn into a magnetic field of 3,000 to 4,000 gauss favors the scarring of wounds. The authors cannot provide any physiological explanations.

Increasing numbers of researchers try to understand the operating mechanism of magnetic fields. For this, they study them, not on living creatures with all their complexity anymore, but on elementary sets (cells, tissues) maintained "in vitro".

Reno and Nutini (66) expose kidney cells of mice embryos to a magnetic field of 7,300 gauss and observed a decrease

(Page 2)

of the breathing rate, a decrease that is even more evident when the embryo is younger. On the other hand, adult cells, subjected to the same conditions, are not affected. The authors believe that strong magnetic fields act on the tissues where the mitotic activity is high. They so explain the results obtained on sarcomatous tissues (Lysina, 37).

Finally, some authors, redoing work on elementary organisms (small molluscs and planarians (6)), have observed the biological effect of very weak magnetic fields, or rather, of their variations.

The geophysicians have indeed shown rhythmic variations of the direction of the earth magnetic field (indeed weak, roughly 0.3 gauss on average). These variations have a definite influence on

the orientation (position in space) and on the metabolism (oxygen consumption) of small molluscs (*Nassarius obsoletus*) during the nycthemere (Ed.: 24 hours circadian cycle).

Some authors believe that some humans (for example, dowzers) can be sensitive to very slight variations, intensity and direction of weak magnetic fields (Rocard (72)).

In parallel to these studies on biomagnetism, the discovery of electromagnetic waves at the end of the 19th century pushes these researches onto a new path. D'Arsonval did think very early about using these waves in medicine.

Nevertheless, overall, the use of some radio waves (HF) in medicine and in biology has often been limited to diathermy only. Yet, as early as 1924, Lakhovski (30), Gosset, Lakhovski et al. (24), obtain rather spectacular results with the tumors caused by *Bacterium tumefaciens* on *Pelargonium zonatum*.

Afterward, advances in technology permitted the development of electromagnetic radiation transmitters of shorter and shorter wavelengths (UHF). Therefore, experiments on the biological effects of radars started approximately 35 years ago.

(Page 3)

The development work by Michaelson (46), published in 1972, permits to realize the large number of researches done in this field during the last quarter of a century (almost 300 publications).

The results observed after application of UHF have been attributed to thermal effects (26, 38, 73, 74, 75, 82, 83, 87, 88) by many researchers. However, it is recognized that, in parallel to these latter ones, there are others called "specific effects" (13, 20, 22, 34, 35, 37, 62).

In France, it was Military Research Centers that got interested into the problem, by first studying the noxious effects caused by radar transmitters (Jody et al. (28)). They were also able to confirm the existence of non-thermal "specific effects". The results of their work revealed among others an effect on: the micro-organisms (Miro (47)), the reticulo-endothelial system (Plurien et al. (61)), the disturbances of electrical cerebral activity (Servantie (76)), (Bertharion et al. (10)), the modifications of sensitivity to certain chemical substances (Servantie et al. (77)).

Yet for all these French and foreign works on bio-electromagnetism, we note a very large variety in the use of different parameters (use of continuous or modulated radiation, power densities varying largely from one experimenter to the next, different durations and exposure conditions, etc . . . ). The analysis and comparative study of all these researches and their results therefore becomes rather difficult.

For many years, we have been doing studies aiming to join both modulated magnetic fields and modulated electromagnetic waves, and to subject many biological models to their effects (8, 17, 45, 53, 54, 55, 56, 57, 67, 68, 69, 70).



It is thus with the collaboration of Mr. Berlureau and Mr. Fournier that we studied the effect of these radiations on the growth and differentiation of certain vegetal and animal tissues. We also showed that, under certain experimental conditions, we could stop the development of spontaneous tumors (7), then with

(Page 4)

Mr. Biraben and Mr. Delmon, of grafted tumors. These latter investigations were followed on with Mr. Rivière and Mr. Guérin.

In this paper, we will reveal the results obtained by the simultaneous effect of both modulated magnetic fields and modulated electromagnetic waves on experimental parasitic affections. They are some blood protozoan diseases: trypanosomiasis and paludism.

## CHAPTER I: EQUIPMENT AND METHODS

(Page 5)

### 1 - STUDY OF THE EMITTED RADIATION

We ended up having successively to design and build: No 1 and No 2 (figures 1 and 2).

Without getting into the details of their conception (\*), we can sketch them as follows (figure 3):

Three antennas, all at the same level and at 120 degrees from each others, are fitted onto a discharge tube into which is created a plasma confined by a longitudinal magnetic field.

One of them transmits a UHF (Ultra-High Frequency) electromagnetic wave while the two others transmit HF (High Frequency) metric waves.

The plasma insures intermodulation of these different electromagnetic waves propagating along the axis of the tube.

We will succinctly describe the intermodulating plasma and the three essential elements of the emitted radiation (UHF wave, HF wave and magnetic field).

#### I - The Plasma

It is created within a Pyrex cylindrical tube of 24 centimeters of diameter and approximately 2 meters high (figure 3). The different parts making the device then fit around it.

After many trials, we used neon as filling gas: it is particularly conducive to an intermodulation of the UHF waves by the modulated HF waves.

The plasma is created between an indirect heating cathode and an anode made of molybdenum. An intermediary electrode, rotating, and equipped

-----

\* Their detailed description was the subject of patents no. 1,342,772 and no. 1,501,984.

(Page 6)

with reflective planes, located at the level of the transmitting antennas, helps the intermodulation of waves and their propagation all along the tube axis.

The operating voltage is roughly 430 Volts for a discharge current of approximately 200 milliamperes.

## II - The UHF wave

This one has a frequency of 9.4 GHz and is generated from a magnetron providing 40 kW peak.

After circulating through waveguides, it is transmitted, via a rectangular horn, into the plasma tube, perpendicular to its axis, at the level of the rotating part described previously. The different reflective planes of this part then reflect the UHF energy parallel to the tube axis, through the plasma.

This UHF emission is pulsing at a Pulse Repetition Frequency of 1 Kilohertz. The Pulse Width is 1 microsecond.

In studying its spatial variation in the plane perpendicular to the axis of the device and at a distance of 5 cm from the exit face of the tube, we obtain the distribution curve given by figure 4. We note that when we get away from the axis of the device, which looks indeed like an axis of symmetry, the decrease in average power is significant. At the axis of symmetry itself, this power corresponds to an average energy density  $W_m$  equal to 10 microwatt per square centimeter.

## III - The HF Wave

The two HF antennas, located at the level of the intermediary electrode, are at 120 degrees from each others and also at 120 degrees from the microwave horn. They are inclined by 15 degrees relative to the plane perpendicular to the axis of the tube. They each transmit (in the current device) a metric wave that is amplitude modulated.

This HF wave is used to:

- 1) modulate the UHF wave via the intermediary of plasma
- 2) maintain the plasma

(Page 7)

The energy of the corresponding HF wave is constant throughout the experimental device.

During this work, we used two wavelengths, one of 19 meters, and the other of 17 meters.

## IV - The Magnetic Field

The longitudinal magnetic field is created by an air coil, with a hollow center of approximately 30 cm of diameter and surrounding the plasma tube. It produces a maximum magnetic field of approximately 1200 gauss at its center. This magnetic field is pulsing at a rate of 50 pulses/minute (figure 5), by an alternating linear motion of coals dipping in an electrolytic bath; this movement is imparted via a crank and connecting rod system.

We measured the spatial distribution of the magnetic field using two ways:

- 1) following the axis of the plasma tube, we obtain the flux distribution shown on figure 6. We note that at a distance of 4.2 cm (the distance from the output of the tube to the experimentation table), the value of the magnetic field is close to 600 Gauss.
- 2) in a plane perpendicular to the axis of the device and distant of 4.2 cm from the end of the output of the tube, the flux distribution is shown on figure 7. We note that the magnetic field is constant on a radial distance of approximately 8 cm from the center.

Besides these essential constituents of the radiation, there are also some accessory constituents present in the visual spectrum.

Indeed, the study of the emission spectrums show the presence of traces of mercury and neon. The former comes from the pumping system used, the latter from the gas used for filling.

Concerning X-ray and gamma radiations, we must point out that we always observed the absence of any emission of these types of radiations.

(Page 8)

## 2- THE PARASITES

We chose two types of protozoa but for which the biology is very different: those that are strictly exo-cellular (trypanosomes), and those that are strictly endo-cellular (hematozoa).

### 2.1. - Trypanosomes

We used:

- Trypanosoma (Trypanozoon) equiperdum
- Trypanosoma (Trypanozoon) brucei gambiense

Table I shows their position in the classification system recently proposed by the World Health Organization (W.H.O.) (65)

In practice, however, these trinomials (Ed.: i.e., three-word terms) and quadrinomials (Ed.: i.e., four-word terms) reveal to be cumbersome. So it is permitted, according to W.H.O. and within the framework of a paper like this one, to restrict ourselves to the simpler binomials (Ed.: i.e., two-word terms) of Trypanosoma equiperdum and Trypanosoma gambiense.

### 2.1.1. - Trypanosoma equiperdum

#### a. The pathogenic agent (Figure 8)

It is the agent for a severe disease among equines: the dourine. It has the very special characteristic to be transmitted only by coition: only the reproductive equines are naturally affected.

The parasite progressively invades all the tissues and organs of the animal, more particularly the circulating blood (where it is present in variable quantities, but always in moderate levels). Death occurs within a variable period (from some months to one or two years) (33).

As is the case for many micro-organisms, the natural behavior (in nature) and the experimental behavior of *Trypanosoma equiperdum* are sometimes slightly different depending of the source, i.e., according to the original pathological case used for their isolation. We commonly talk about parasitic “strains”.

Most of our experiences were realized with the strain labelled “from Pasteur Institute of Paris”; this strain was

(Page 9)

provided to the Medicine Faculty of Bordeaux (Immunological and Parasitic Biology Laboratories) in 1961 by Professor Colas-Belcour.

Another strain, dyskinetoplastic, was exceptionally used and it was kindly provided to us by Professor Von Brand (Laboratory of Parasitic Diseases, National Institute of Health, Bethesda, Maryland, USA).

Let us point out that these two strains of *trypanosoma equiperdum* can be conserved at cold temperature (less than or equal to -80 degree Celsius), for example under the form of blood concentrated in parasites, glyceroled, and adequately frozen (by progressive freezing).

#### b. Antigenic variation

We must now evoke a very important notion: the antigenic variation. This notion, already ancient, but more easily approached today thanks to modern technology (more specifically the help of the cryo-conservation processes), is necessary for the comprehension of the experimental results that will be tabled below.

Everything is happening as if this antigenic variation permitted the parasite to resist, when needed, to the immune reactions of the host. This is indeed the case when the disease (natural or experimental) develops in a sufficiently prolonged or chronic mode. Under such conditions, we observe, in the host organism, a succession in time of parasitic types that are different from each others by their immunological properties. We call these

parasitic types (and this to avoid prejudging their apparition mechanism) “antigenic types” or “antigenic variants”.

The accurate analytical study of antigenic types can be done via the production of parasitic clones, ie., of homogeneous populations derived from a lone parasitic cell (see below, same chapter, paragraph 4.1.2.). Concerning the strain “Pasteur Institute of Paris” of *Trypanosoma equiperdum*, the Research Unit on Immunology of Parasitic Affections (under INSERM, in French: Institut National de la Santé et de la Recherche Médicale) of Bordeaux currently owns more than a hundred isolated antigenic types.

(Page 10)

The antigenic types are thus distinguished from each others essentially from their immunological differences, which means that antisera made against these antigenic types permit to isolate and to recognize them. This is equivalent to observing that certain parasitic antigenic structures appear as specifics of antigenic type. Other antigenic structures, on the other hand, seem common to all antigenic types from a same strain.

Among the specific antigenic structures of antigenic type, the most common are the agglutinants antigens; these are surface antigens. The immunological reactions that permit to distinguish the antigenic types from each others are thus essentially agglutination reactions. A specific antiserum of a determined antigenic type thus contains (among the mass of anti-trypanosomes antibodies) antibodies agglutinating specifically the trypanosomes of that antigenic type while excluding all other antigenic types. We must point out that during these reactions, the trypanosomes remain alive among the agglutinates (persistence of movements of the undulating membrane and of the flagellum)(see below, same chapter, paragraph 5.3.3.b).

Among all the antigenic types of a strain, there is a preferential type called basic antigenic type (or basal); we will rediscuss it again a few times below. For all the experiments performed in the present paper, we infested the animals (unless mentioned) with the basal type (called E1) from the strain “Pasteur Institute of Paris”.

### 2.1.2. *Trypanosoma gambiense*

This is the agent for the African human trypanosomiasis (or “sleeping disease”).

The transmission from human to human is done by the intermediary of stinging insects, of flies belonging to the genus *Glossina* (“Tsetse fly”). A parasitic cycle is thus developing successfully on two natural hosts, the sick human and the glossine.

In the glossine as a carrier, the parasite undergoes a series of evolution stages resulting into the infecting form (called metacyclical)

(Page 11)

which settles within the salivary glands and the probe. These parasitic forms existing in the carrier insect are of no interest in the present paper.

In the sick human, we classically admit the existence of the flagellated form only (trypomastigotic form). The parasites are present in the blood, the lymphatic ganglions, the bone marrow (at very variable levels, and sometimes very weak) and in many organs, particularly the nervous system. However, we should mention that since the beginning of this century, some authors, basing themselves on criteria of comparative parasitic pathology, suspected the existence within humans of parasitic forms different from the trypomastigotic forms, particularly in the meninges and the choroid plexus of the brain; we will briefly rediscuss this problem below.

In the case of the *Trypanosoma gambiense*, the notion of strains is equally very important, particularly concerning their experimental behavior. For the experiments performed in the current paper, we used the strain D2/1 isolated by Mattern, in 1963 in Senegal, around the area of Rufisque (44).

The conservation in a laboratory can be done under the same conditions as with the *Trypanosoma equiperdum*.

The antigenic variation exists also in *Trypanosoma gambiense*; it was studied in other parasites of the brucei species. However, concerning the strain D2/1, the study of this antigenic variation is difficult; we will see why later. We were nonetheless able to get some cloned populations.

## 2.2. - Hematozoa

We chose *Plasmodium Berghei* (subgenus *Winckeaia*), a paludism agent in rodents.

The evolution cycle of the parasites of genus *Plasmodium* goes on in two hosts: a vertebrate host (rodent) and a carrier insect (mosquito of genus *Anopheles*). This cycle includes two stages: an asexual stage and a sexual stage. The first (diploid elements) is present in rodents;

(Page 12)

it results into sexual elements, the male and female progametocytes that, absorbed by the carrier insect during the blood meal, will be at the origin of the sexual stage of the cycle; this one finally ends with the presence of infectious forms, the sporozoites, within the salivary glands.

The asexual stage of the cycle, in the rodent, includes in reality 3 types of elements:

- exo-erythrocytic elements that will develop within the cells of certain organs (liver) and of the reticulo-endothelial system. These elements produce primary and secondary exo-erythrocytic schizogonies (11, 81).
- endo-erythrocytic progametocytes, but in reduced number.
- endo-erythrocytic elements, which evolve strictly within the red blood cells, and which produce a series of classic schizogonies (figure 9)

In the framework of the current paper, only endo-erythrocytic schizogony elements are considered. These elements are thus strictly endo-cellular, except the merozoites between the time of their release, by the rosacea burst of their bodies, and the time of their penetration in new red blood cells; but these exo-cellular stages are brief.

(Page 13)

### 3- THE HOST ANIMALS

During our thesis, we used the 3 following species of animals: mice, rat and rabbit.

#### 3.1. - Mice

Those are of Swiss race, of female gender, 4 weeks old, having a weight from 18 to 20 grams. Their source is the following:

Breeding Farm for Laboratory Selected Animals  
(Mr. Martin) / 33910 St Denis de Pile (Ed.: probably near Bordeaux, France)

#### 3.2. Rats

Those are of Wistar race, of female gender, approximately 5 weeks old, having a weight from 120 to 150 grams.

They come from the same breeding farm as the mice.

#### 3.3. Rabbits

Those are Fauve de Bourgogne (Burgundy Wild Beast), of male gender, 12 weeks old, having a weight from 2.5 to 3.0 kilograms.

They come from the following breeding farm:

Mr & Mrs Bellocq / 64370 St Medard (Ed.: probably near Bordeaux, France also).

### 4- THE PARASITIC MODELS

#### 4.1. - Acute Trypanosomiasis with T. Equiperdum

This model is produced by the evolution of Trypanosoma equiperdum in mice and rats.

##### 4.1.1. - Characteristic of the disease

In the following, we will be talking essentially about the acute trypanosomiasis of the mouse. However, we must first state that the observed phenomena are quite similar in the rat infested with Trypanosoma equiperdum.

From the time of inoculation (which, usually, is done via intra-peritoneal way), the trypanosomes multiply rapidly. Very quickly, they invade the circulating blood, and their number increases in a

continuous fashion until the death of the animal; then the parasitemia is close to  $1.0E6$  per microliter of blood (fig 8).

This increasing and inexorable progression of the parasitemia is effectively the major sign of the experimental disease in the mouse. At the autopsy, we note a very congested liver, a spleen that is considerably increased in volume, and a hypertrophy of the lymphatic ganglions corresponding to the inoculation point (mesenteric ganglions). The parasites are present in the parenchyma of all organs.

The speed of evolution (survival time of the inoculated mice) depends mostly on the quantity of inoculated parasites. Figure 10 shows the almost linear relation that exists between, on one hand, the number of trypanosomes inoculated, and, on the other hand, the survival time of the mice.

In the experiments described further down, we often used an inoculum of  $2.0E4$  parasites; figure 11 shows the evolution of the parasitemia for such inoculum (the death of the mouse occurs within 90-110 hours).

To obtain an evolution similar to the one that happens in the mouse (parasitemia and survival time), let us point out that, for the rat, you

(Page 15)

need usually to use an inoculum approximately 10 times as large.

#### 4.1.2. - Antigenic variation

Figure 10 also shows that the parasitic unit is infecting; this property is very important: it permits to obtain homogeneous populations by cloning. The inoculation of a lone parasitic cell in the peritoneal cavity of the mouse can be made with the help of thorough dilutions techniques. The evolution of the disease ends with death within 7 to 10 days.

It is thanks to the production of parasitic clones that it has recently become possible to approach the immunological study, and even immuno-chemical, of the antigenic variation, i.e., of the different antigenic types.

In practice, we must of course avoid that the clonal population, obtained from the mouse inoculated with a lone parasitic cell, undergoes in turn the antigenic variation during the evolution of the disease that is quite long (7 to 10 days). In that case, the antigenic variation (which generally happens around the 4th-5th day) always develops toward the basic type E1. To avoid this variation, we can use repeated blood transfers (about 0.25 to 0.5 milliliter) from mouse to mouse, for example every 48 hours (i.e., before the appearance of important immunity reactions); better, we can use these repeated blood transfers on mice treated with certain drugs called immuno-suppressive (for example, the cyclo-phosphamide, which does not seem to have any harmful effects on trypanosomes). At each transfer, the number of inoculated parasites increases, and we are finally able to produce massive infestations (of the order of  $1.0E6$  parasites), mortal within 48 hours, and permitting the collection of large quantities of homogeneous populations (or antigenic types).



Concerning the experiments described in the current paper, we stated to have generally inoculated large quantities of parasites,  $2.0E4$  or even more. Under such experimental conditions, where the disease evolves during a short time (less than 120 hours), the antigenic variation does not seem to show up, the disease evolves from a single type from the point of view of antigenic types.

But we will see below that under other circumstances (isolation of antigenic types from trypanosomed rabbit), we can

(Page 16)

consider inoculating the mouse with much lower quantities of parasites; the death of the mouse then occurs later (5th or 10th day after inoculation). The antigenic variation, toward the basic type E1, can then become possible. To avoid it, we proceed as described above: repeated blood transfers on mice treated with immuno-suppressive substances.

The immunological phenomena that occur during the acute trypanosomiasis of the mouse and rat are described further below.

#### 4.2. - Chronic trypanosomiasis

This is about experimental parasitosis with a much longer evolution cycle than those described previously. Two models were used:

- the trypanosomiasis of rabbit with *Trypanosoma equiperdum*
- the trypanosomiasis of mouse with *Trypanosoma gambiense*

##### 4.2.1. - Experimental Trypanosomiasis of rabbit with *T. Equiperdum*

###### a. Evolution of disease

For the experiments described in the current paper, we inoculated some large quantities of parasites ( $5.0E6$  to  $2.0E8$ ) to the rabbits by intraperitoneal way. It seems that the volume of the inoculum has no major influence on the development of the disease.

The first pathological signs generally appear during the 2nd week of the disease. An irregular fever sets in: the temperature (which is normally around 38.5 to 38.8 degree Celsius) shows sudden and irregular increases to 40-41 degree Celsius. Some oedemas show up, in particular near the muzzle and the ears (which become hot and droopy). The problems become more evident. For the ears, the skin becomes dry, covered with scales; the hair falls and scabs form. For the eyes, a mucopurulent conjunctivitis appears. The animals can show some nasal discharge; the nostrils are covered with a thick crust under which the tissues are destroyed. The limbs get infiltrated and ulcerated; a paresis of the hindquarter can occur. The general state worsens, the loss of weight is progressive until the fatal cachexy. Death occurs usually after 5 to 10 weeks of evolution, sometimes more (figures 13 and 14).

(Page 17)

The attack of external genital organs must also be mentioned. In male animals, for the testicles, some oedema appears approximately 2 weeks after the infestation. Very often, orchitis propagates to the skin of the scrotum; the overinfection occurs and the series of those phenomena results in the loss of the gland (figure 15).

The trypanosomes are present in the blood (but the parasitemia is still weak, infra-microscopic), in the oedemas and around ocular and nasal mucous membranes; the parasite exists also in most of the organs, in particular around testicular lesions.

The autopsy shows, in particular, a hypertrophy of the lymphoid formations.

b. Histological study of the testicular lesions

The histological study of the testicular lesions is particularly interesting (figure 16). It permits, in fact, to evaluate the problems from the two functions of the gland:

- the exocrine function, i.e., the spermatogenesis (state of many parts of the tubing when looking at the seminiferous tubes; presence of spermatozoids in the openings of the epididymal tubes).
- the endocrine function, i.e., the working of the interstitial gland, using the aspect of the epididymal epithelial cells.

Already, eight days after the infestation, the animals generally display a beginning of orchitis. The histology shows a lymphocytic infiltration of the epididymis. The testicular parenchyma does not present any visible alterations yet. The seminiferous tubes have a normal aspect and contain spermatozoids and the interstitial gland is well developed. The structure of the epididymis reveals the presence of spermatozoids in the openings of tubes and the existence of a palissadic epididymal epithelium, and of prismatic cells attesting the presence of androgenic hormones in the organism (figure 17).

Fifteen to twenty days after the infestation: the orchitis has developed quite a lot. The seminiferous tubes of the testicles have decreased quite a lot in size, the spermatogenesis has disappeared from them and their structure is reduced to the Sertoli cells and to some spermatogonis. The interstitial gland

(Page 18)

is atrophied, with a lymphoid infiltration in the inter-tubular conjunctive tissue. In the epididymis, the tubes present an atrophied epithelium, low cubic and their openings are empty, containing no spermatozoids. We find numerous and voluminous centers of lymphoid infiltration and pictures of conjunctive tissue sclerosis of the epididymis. In short, the testicle is affected in its two gametogenous and hormonogenous functions (figure 18).

Thirty days after the infestation: the lesions are much more evident. The testicles are infiltrated by leucocytes and sprinkled with necrotic areas. The few seminiferous tubes that

remain are limited to the sertolian tube and the interstitial gland is not recognizable anymore. The epididymal canals are empty and their epithelium is quite flat (figure 19).

c. Antigenic variation

From the parasitological point of view, the disease is characterized by a succession, in time, of many antigenic types. A given type persists only for a few days (2 to 3); before its disappearance, the successor type takes over, and so on. At the time of change, the 2 types involved can coexist for some hours (Capbern (12)) (Figure 20).

In the experiments described in the current paper, the rabbits were infested with the basic type E1; as with the other antigenic types, the basic type disappears after 3 days of evolution.

The successive antigenic types can be isolated and characterized from the peripheral circulating blood, and this in spite of the very weak, infra-microscopic parasitemia. We proceed as follows: blood is collected from the rabbit (0.25 to 0.5 milliliter) and inoculated to the mouse, in which the trypanosomes (little in number at the start) will multiply rapidly. When the parasitic population will be large enough, we practice the analysis of the antigenic types with the help of type specific agglutinants anti-serums. There, again, we need to avoid of course the antigenic variation and we proceed as described above for the production of homogeneous cloned population.

The immunological phenomena, which are very evident, will be described further below.

(Page 19)

4.2.2. - Experimental Trypanosomiasis of the mouse with T. Gambiense (strain D2/1)

For the experiments described in the current paper, we inoculated  $1.0E3$  trypanosomes to each mouse.

The experimental disease evolves schematically in the following manner (Mattern et al. (44)). A first phase, which lasts approximately 15 days, is characterized by a moderate parasitemia. Two evolutions are then possible (figure 21):

- alpha type: approximately 70 to 80% of mice present an increasing parasitemia, leading to death around the 20th day.
- beta type: approximately 20 to 30% of the animals survive. The parasitemia appears negative (we do not detect any parasites under microscopic examination). We can speak of latent period. Nevertheless, after a variable time from one mouse to another (which can reach up to 7 months), an increasing and fatal parasitemia invariably occurs. Not one mouse ever heals spontaneously.

At the moment of the pre-agony phase (in alpha or beta type), the parasitemia is massive and can reach higher than  $1.0E6$  parasites per microliter of blood.

After some months of evolution of the beta type, the animals often present clinical signs, in particular a paresis of the hindquarter and a vesical retention. At the autopsy, we find a hypertrophy of the lymphatic ganglions, and, often, a very large splenomegaly (the weight of the spleen that, is normally inferior to 0.1 gram, can reach and even become higher than 2.0 grams).

These same mice can present, after a few months of beta type evolution, parasitic forms different of the trypomastigotic flagellated forms. These forms are of small size (1 micron), round or oval, with flagellum. We call them amastigotic forms. They are localized in the choroid plexus of the brain, in extra-cellular position (Mattern et al. (44)).

We saw that the antigenic variation was difficult to study in this parasitic model, essentially due to the slower evolution

(Page 20)

of the parasitosis.

The immuno-biological phenomena, equally very evident too, will be described further below.

#### 4.3. - Paludism of the mouse with P. Berghei

For the experiments described in the current paper, we inoculated  $1.0E4$  parasites (endo-erythrocytic forms) to each mouse, via intra-peritoneal way. During the first five days, the parasites are not detectable in the peripheral circulating blood: this is the latent phase. Then, the parasitemia appears and increases progressively. Death occurs around the 15th day; at that time, 40 to 50% of the red blood cells are parasited by endo-erythrocytic forms (figure 9).

### 5 - METHOD OF STUDY OF HOST ANIMALS EXPERIMENTALLY INFESTED IRRADIATED AND NON-IRRADIATED

#### 5.1. - Clinical observation

We note the general state of the animals, their survival time after infestation, the clinical signs that may appear (fever, loss of weight, paresis of limbs, etc . . . ).

#### 5.2. - Parasitemia - Negativation

Parasitemia, i.e., the presence of parasites in the circulating blood, is an essential sign.

##### 5.2.1. - Acute Trypanosomiasis of the mouse and of rat with T. Equiperdum

We observed that the parasitemia could reach high values during the pre-agony phase (larger than or equal to  $1.0E6$  parasites per microliter of blood).

Two evaluation techniques were used:

- a) a quantitative technique. The blood, drawn from the tail of the animal, is quickly dissolved in physiological saline water in adequate proportion (with the help of a Potain's mixing pipette), then deposited into a cell permitting the numeration (Malassez cell). We thus calculate the number of trypanosomes present in 1 microliter of blood.
- b) a semi-quantitative technique, but with a precision nonetheless sufficient usually to quickly appreciate the evolution of the parasitemia. The technique boils down to counting the number of parasites in the blood deposited between the slide and the lamella (examination while the blood is fresh) and observed under microscope using a constant magnifying power (400 times). We convey the results via a number of crosses, ranging from 1 to 4 according to the approximative number of parasites present in the field of the microscope.

(Page 22)

So:

- + corresponds to approximately 1 to 5 parasites
- ++ corresponds to approximately 5 to 20 parasites
- +++ corresponds to approximately 20 to 100 parasites
- ++++ corresponds to approximately more than 100 parasites

per field of the microscope.

Figure 8 shows fields of microscope corresponding to the 4 values.

In comparing the two techniques, we find that:

- + corresponds to approximately less than or equal to  $1.0E3$  parasites per microliter
- ++ corresponds to approximately  $1.0E4$  parasites per microliter
- +++ corresponds to approximately  $1.0E5$  parasites per microliter
- ++++ corresponds to approximately more than  $1.0E6$  parasites per microliter

Under certain circumstances, for example under the effect of a treatment, the parasitemia can decrease and become nil; we define this apparent absence of parasites under microscopic examination with the term "negativation". This designation does not mean a real absence of parasites in the peripheral circulating blood; it is indeed possible that some parasites are present, but at a concentration too weak to be detected with microscopic observation.

If we want to confirm the real absence of parasites in the blood, we must resort to more advanced techniques, in particular, the inoculation of the suspect blood to new mice. We know indeed that the parasitic unit is infecting. Let us remember that we are then under experimental conditions of inoculation of a small number of parasites and that if we wish to avoid the antigenic variation, we must take the precautions described above (see above, same chapter, paragraph 4.1.2.).

5.2.2.- Chronic Trypanosomiasis of rabbit with *T. Equiperdum*

The parasitemia is always weak, infra-microscopic; to detect it, we must constantly resort to [blood] transfers on mice. However, this parasitemia exists all along the evolution of the disease. (Figure 22).

(Page 23)

We already discussed the isolation and the characterization of antigenic types (see above, same chapter, paragraph 4.2.1.c.).

### 5.2.3. - Chronic Trypanosomiasis of the mouse with *T. gambiense*

The parasitemia can be nil, at least in appearance (during the latent phase), moderate (during the first 15 days of the disease), or massive (during the pre-agonic phase) (Figure 21).

The confirmation of a really negative parasitemia requires, here again, the transfer of the suspect blood into new mice; these shall be examined using criteria that will be defined further below (see below, same chapter, paragraph 5.3.1.d. and paragraph 5.4.2.).

### 5.2.4.- Paludism of the mouse with *P. Berghei*

The parasitemia constitutes the major sign. Its evaluation is done in a semi-quantitative manner; we find out the proportion of parasited red blood cells (by endo-erythrocytic forms) relative to the total number of red blood cells and we state the results in % (Figure 9).

## 5.3. - Study of the immune status

It is the study of the reactions of immunological nature that occur in host animals of the many parasitic models. In fact, such a study was done only for the 3 models of trypanosomiasis (we will see the reasons further down, under the chapter “RESULTS”, paragraph 7).

The study of the reactions of immunological nature was undertaken at three levels:

- repercussion of the experimental disease on the concentration of certain immunoglobulins in the plasma
- the research of a state of immune protection
- the analysis of the evolution of certain circulating anti-trypanosomes antibodies.

### 5.3.1. - Serous levels of G and M immunoglobulins (IgG and IgM)

We particularly studied these two immunoglobulins for the following reasons:

(Page 24)

- the IgG is ponderously the immunoglobulin that is normally the largest (approximately 10 milligram/milliliter of serum, as well in the rabbit as in the mouse.)
- the IgM for a particular reason that will be mentioned below (see below, same chapter, paragraphs 5.3.1.c. and 5.3.1.d.).

a. Dosage technique of the G and M immunoglobulins

These are immuno-chemical techniques.

We essentially used, in the current paper, a semi-quantitative technique of double diffusion in a gel of gelose (Ed.: agar-agar) (at 1.3%)(Mattern (41)). It consists in opposing to a monospecific immunserum (anti-IgG or anti-IgM of the rabbit or the mouse) some successive dilutions (in geometrical progression of base 2) of the serum to be tested. Precipitation lines appear; we note their intensity and their position and compare them with those obtained, either with a pool of serums coming from normal animals, or either (and this was the case all along this work) with the serum sampled, before the experimentation, from the same animal.

This dosage technique permits to say whether a level of IgG or IgM has increased or decreased by a certain number of times. Figure 23 shows the case of a rabbit where the drawn sample B contains approximately 6 times more IgM than the drawn sample A (done before experimentation), Although semi-quantitative, this technique is sensitive and very reproducible. Furthermore, it is the only one possible concerning, in particular, the IgM dosage of rabbit; we did indeed show (Klein et al. (29)) that for this immunoglobulin, the simple radial diffusion technique (Mancini (4)) was unapplicable.

The variations of serous levels of the IgG and the IgM reflect, of course, on the albumin/globulin ratio of the serum. The albumin level having usually a tendency to vary in inverse direction, it follows that the study of the albumin/globulin ratio can be very interesting. The determination of this ratio is simple: electrophoresis, for example, of cellulose acetate and quantitative evaluation of albumin and globulins via densitometry after coloration (43).

b. Evolution of G and M immunoglobulins during acute trypanosomiasis of the mouse and rat with *T. Equiperdum*

Usually, the disease evolves too rapidly for

(Page 25)

detecting significant modifications of levels of the two immunoglobulins.

However, when the inoculum contains very few parasites and that the disease evolves during more than 7 days, we can observe a moderate increase of the serous level of IgM (4 to 8 times the normal level), i.e., the one that existed in the same animal before the infestation.

c. Evolution of G and M immunoglobulins during the chronic trypanosomiasis of rabbit with *T. Equiperdum*

In this parasitic model, the modifications are very significant (figure 22)

The level of IgG increases in most animals during the disease. The intensity of this increase is however very variable from one animal to another (from 2 to 8 times the normal level); furthermore, for a same animal, it can be subject to important fluctuations.

On the other hand, the variations of the serous level of IgM are quite stereotyped. In all animals, this level increases from the first week of the disease to reach its maximal value approximately 15 days after the infestation (value, which depending of the animals, is of the order of 6 to 16 times the normal level). The increase of IgM persists all along the disease. This increase of the IgM serous level is thus an absolutely constant phenomenon during the chronic trypanosomiasis of the rabbit with *T. Equiperdum* (Mattern et al.(43)).

The albumin serous level decreases rapidly, also from the first days of the disease. Given the behavior of the two G and M immunoglobulins, the ratio albumin/globulin (which stands normally between 1.5 and 2.0) can reach very low values (down to values close to 0.3).

- d. Evolution of the G and M immunoglobulins during the chronic trypanosomiasis of the mouse with *T. Gambiense*.

In this chronic model, the increase in value of the IgM serous level is still more characteristic, in the sense that (figure 21):

- the level increases from the first days after the infestation, to reach a maximal value (between the 15th and the 20th day), which is still again more elevated than those in the trypanosomed rabbit (from 20 to 30 times the normal level, depending on the animals.)

(Page 26)

- this level persists as a ceiling during the whole duration of the disease (which may be as much as 7 months for an evolution of beta type); there is no weakening during the periods of parasitological latency.
- this increase of IgM level is really preferential: in fact, the IgG level increases much less or even not at all.

The study of the evolution of the serous IgM thus becomes a favorite investigation method (simple and faithful) in the models of chronic trypanosomiasis (trypanosomiasis of rabbit with *T. Equiperdum* and trypanosomiasis of the mouse with *T. Gambiense*). We can say that a high serous IgM level is characteristic of a trypanosomiasis in evolution.

This finding agrees entirely with the one made during the human African trypanosomiasis with *T. Gambiense*, an affection also of long duration (Mattern (41)).

### 5.3.2. - State of immune protection



We can define this state in the following manner: it permits to an experimental host organism to resist more or less, and with the help of its immune reactions, to a normally infesting dose of trypanosomes.

It is classic to say that the state of immune protection is specific of antigenic type.

### 5.3.3. - Study of certain humoral antibodies

In the experiments described in the current paper, we researched and labelled four types of circulating antibodies (or rather four antibody properties), namely the:

- agglutinants antibodies,
- hemagglutinants antibodies,
- precipitants antibodies, and
- sero-protective antibodies.

The research and the titration of these antibodies were done

(Page 27)

mainly in the experimental models where the pathogen agent is *trypanosoma equiperdum*, i.e., where we can take advantage of homogeneous parasitic populations for the fabrication of antigenic reagents. The titers of these antibodies are always expressed by the inverse of the last serous dilution that still produces a positive (serologic) immunological reaction.

Before to describe the immunological techniques permitting the research and titration of four humoral antibodies, we must mention a brief word concerning the general antigenic structures of *Trypanosoma equiperdum*.

#### a. (General) antigenic structures of *T. Equiperdum*

Certain of these structures appear (to the parasitic body) closely linked to the cellular state. They become freed in the ambient environment only via the disintegration of parasitic bodies: we then talk about somatic antigens.

Other antigenic structures, although also developed by the parasitic cells, diffuse easily into the ambient environment, as well “in vivo” (plasma of the infested animal) as “in vitro” (for example, in a solution that permits the survival of parasites for a few hours): we speak of exo-antigens. These antigens are thus present at the same time within the parasitic cells or at their surface, and in the ambient environment.

The antigenic structures corresponding to agglutinants antibodies and to precipitants antibodies are, at least partially, exo-antigens. For the antigenic structures that correspond to hemagglutinants antibodies and to sero-protective antibodies, the question does not seem to have been settled, at least to our knowledge.

Just as the agglutinants antigenic structures, the structures that correspond to sero-protective antibodies are specific of antigenic type. On the other hand, the antigenic structures that come into play in the hemagglutination reactions are common to the antigenic types overall. The precipitant antigenic structures belong to two types: some are specifics of antigenic type, the others are common to the antigenic types overall (table II).

(Page 28)

b. Agglutinants antibodies

In practice, we used the technique of Pautrizel et al. (51, 84). The antigenic reagent was always composed of a homogeneous suspension of antigenic type of base E1. We have thus in fact titrated uniquely the antibodies agglutinating specifically the type E1.

Let us point out that the parasites remain alive (mobiles) during the reaction.

The antigenic reagent contains  $2.0E4$  parasites per microliter. On a Kline plate, a drop of this suspension is placed in contact with a drop of serum to analyze and of its successive dilutions. The reading is made, after a contact time of 30 to 45 minutes within a humid chamber.

c. Hemagglutinants antibodies

They agglutinate to red blood cells (of sheep) having bound some antigenic substances of *Trypanosoma equiperdum* to their surface.

These antigenic substances are obtained as follows. Mice or rats are infested with the antigenic type of base E1. When the parasitemia is very high (larger than or equal to  $1.0E6$  trypanosomes per microliter of blood), the blood is collected, mixed with heparin (1 microliter for 1 milliliter of blood), then deposited on top of a 3 centimeter thick layer of DEAE-cellulose, in equilibrium in a glucosed phosphate buffer pH 8 and placed in a Buchner filter. Under these conditions, the plasma and the trypanosomes filter rapidly through the DEAE-cellulose layer, while the figurative elements from the blood are retained (31).

We thus the trypanosomes and execute three successive washes with the buffer solution, with the aim to eliminate the plasmatic proteins. The last deposit from centrifugation is reused within an equal volume of buffer, and this concentrated suspension of trypanosomes is deposited in a Hughes' Press at a temperature of -50 degree Celsius. The suspension of trypanosomes thus frozen is then subjected to a pressure of 10 tons per square centimeter, under the effect of which the product liquefies and is brutally expelled through a 0.5 millimeter wide slot. After the passage, the product, which is no longer subjected to this strong pressure, freezes back right away. This liquefaction at low temperature creates a disintegration of parasitic bodies.

(Page 29)

The product of disintegration is collected, then cleared of insoluble particles by centrifugation for 30 minutes at 20,000 g. The top part, which contains the parasitic antigenic substances in solution, is in fact the antigenic reagent; it contains both the somatic antigens and the exo-antigens. It is adjusted to a total protein concentration of 5 milligrams per milliliter.

The proteins of the antigenic reagent are bound to the walls of the sheep red blood cells by a chemical link, with the help of glutaraldehyde; for this binding as well as for the practical execution of the reaction (which we call a passive hemagglutination reaction, the red blood cells only playing a passive support role), we got the inspiration from the works of Tribouley et al. (85) concerning same type of reactions used for the study of distomatosis.

Let us recall that the hemagglutinants antibodies, just as the antibodies binding the complement (52), are common to the overall antigenic types of a strain of *Trypanosoma equiperdum* (for example, our strain "of Pasteur Institute of Paris").

d. Precipitants antibodies

We reveal them by using immuno-precipitation techniques in a gel environment (gel of gelose). In the present paper, we used the double diffusion (Ouchterlony type) and accessorially the immuno-electrophoretic analysis (Mattern (41) and Mattern et al. (42)) (Figures 24 and 25).

The antigenic reagent is similar to the one described in the preceding paragraph but more concentrated (10 milligram/milliliter of total proteins).

With a determined serum, coming from an infested animal, we can obtain many lines of precipitation (up to 5); this really shows that the precipitant antigenic structures are multiple and that each of them induces, for its own purpose, the formation of corresponding antibodies in the host organism.

It is thus difficult to speak of titer, because each structure obviously has its own particular titer; this analysis appears impossible for the moment. In practice, we had to limit ourselves to a total titer: the last dilution still giving a line of immunological precipitation.

(Page 30)

In certain cases, where the serum contains low quantities of precipitants antibodies, no precipitation line is apparently observable. We must then resort to the technique of successive fillings with an antibody reagent (as soon as the antibody cup is empty, a new filling is made); we thus had to do 2 to 3 successive fillings. The global titers of corresponding precipitants antibodies are thus  $\frac{1}{2}$  or  $\frac{1}{3}$ .

e. Sero-protective antibodies

The research principle of sero-protective antibodies is the following (Pautrizel (50)):

- in a first time, inject to a test-organism, which is a normal mouse here, 0.50 milliliter of serum (or of its dilutions) coming from the animal that is supposed to produce these antibodies.
- in a second time, and 24 hours later, inoculate the test-mouse with a defined infecting dose of trypanosomes, here  $2.0E4$  parasites belonging to the antigenic type of base E1. We observe the eventual appearance of a trypanosomiasis in the test-mouse.

Depending on the concentration of sero-protective antibodies in the analyzed sample, the protective power can be total (it prevents the development of an acute trypanosomiasis) or partial (the trypanosomiasis develops but with a certain lag relative to the control mice having first received a normal serum exempt of antibodies).

Let us point out that the sero-protective antibodies are specifics of antigenic type.

With the aim to confirm the immunoglobulinic nature of the sero-protective power, we had to practice a preparative ultra-centrifugation technique on continuous gradient of saccharose (from 5 to 20%). The analyzed serum sample was 0.4 milliliter; after the centrifugation (24,000 rpm, for 13 hours; centrifuge Beckman-Spinco, Model L/L2, Rotor SW-40), we collected 12 fractions of 1 milliliter. We researched

(Page 31)

for each fraction:

- the sero-protective power
  - the G and M immunoglobulins level.
- f. Evolution of humoral antibodies during the acute trypanosomiasis of the mouse and rat with *T. Equiperdum*

During these acute trypanosomiasis, the humoral antibodies are practically undetectable, probably because of the speed of evolution of these diseases. Everything occurs as if the antibodies, throughout their elaboration, unite with the corresponding parasitic antigens, in particular with the exo-antigens present in the plasma of animals rapidly hyperparasited.

- g. Evolution of humoral antibodies during the chronic trypanosomiasis with *T. Equiperdum*

The different humoral antibodies are detectable, often at elevated titers and all along the evolution of the disease (figure 26)

The first antibodies that appear are the agglutinants antibodies directed against the antigenic type of base E1 that served for inoculation. One week after the infestation, the titer is generally already maximal, (this titer is of 25,000 for the RR14 rabbit of figure 26). After this maximum, the titer decreases progressively and can become very low (so in the

RR14 rabbit, which lived exceptionally long, it reaches the titer of 50). This progressive decrease can be understood easily: the corresponding antigenic stimulation, i.e., the evolution of the parasite of antigenic type of base E1, occurred really only during the first few days of the disease, the first three approximately following the type of base E1, the other antigenic types successively relay themselves, as we stated above (see above, same chapter, paragraph 4.2.1.)

The hemagglutinants antibodies that appear a bit later behave differently: their maximal titer (40,000 to 80,000 for the RR rabbit) remains at its maximal value all along the disease. The reason being that the corresponding antigens are common to all the antigenic types that will relay themselves in the trypanosomed rabbit.

The precipitants antibodies appear much more tardively and also persist all along the disease. The reason being that

(Page 32)

certain corresponding antigenic structures are common to all the antigenic types.

#### 5.4. - Criteria of parasitological healing

Concerning the current thesis, the notion of parasitological healing is essential.

##### 5.4.1. - Experimental Trypanosomiasis due to *T. Equiperdum*

We said above (see above, same chapter, paragraph 5.2) that the negativation of the parasitemia (parasites non detectable under a microscopic exam), and also the real absence of parasites in the circulating blood (evidenced by inoculation to normal mice of the blood to analyze) are not absolute criteria of healing; indeed, some parasites can subsist, in more or less important numbers, in certain organs of the host-animal (spleen, liver, bone marrow, brain, etc . . . )

To confirm the parasitological healing, we must thus take those various organs and make some grinded compounds that are inoculated to new mice. The absence of trypanosomiasis in new mice can be considered as an absolute criterion of parasitological healing.

Concerning the chronic trypanosomiasis of the rabbit, a good criterion is equally produced by the regression, followed by the normalization, of the serous IgM level. The regression starts immediately after the disappearance of parasites and the normalisation occurs usually after approximately 4 weeks.

##### 5.4.2. - Chronic trypanosomiasis of the mouse with *T. Gambiense*

The remarks stated in the precedent paragraph are also valid there, particularly concerning the evolution of the serous IgM level.

A particular remark must be made, concerning the inoculation of suspect material (blood or ground up organs) to normal mice. The study of parasitemia, in inoculated mice, is often difficult

and tedious, given the small number of parasites present in the material of [blood] transfers. It is then very useful to monitor the serous IgM level of these animals.

## CHAPTER II: RESULTS

(Page 33)

The device that we conceived emits a radiation of which the main components are a HF wave, a UHF wave and a magnetic field. We will describe below the effects obtained by the effect of this radiation on the four parasitic models used:

- Acute Trypanosomiasis of the mouse and rat with *Trypanosoma equiperdum*
- Chronic Trypanosomiasis of rabbit with *Trypanosoma equiperdum*
- Chronic Trypanosomiasis of mouse with *Trypanosoma gambiense*
- Paludism of rat with *Plasmodium Berghei*

An important note must now be stated. The results, which we are reporting here, are only a part (approximately the third) of our total experimentation. Often, in fact, experiments had to be interrupted for reasons beyond our control: failures of various parts of our devices. We must point out that our two devices were built under difficult financial conditions.

We said above (see chapter “Equipment and Methods”, paragraph 1) that we had to conceive and successively build two devices No 1 and No 2.

So, we will start by presenting in a chronological order the first results obtained successively with the two devices. These first results permitted to define and to fix certain experimental conditions that helped the larger part of experiences to be done.

(Page 34)

### 1 - THE FIRST IRRADIATION EXPERIMENTS

#### 1.1. - Irradiation experiments with device No 1.

They were able to be done as early as 1966.

##### a. Characteristics of the device

Let us point out some essential characteristics of this device:

- magnetic field of 600 Gauss at the output face of the tube
- power of the HF transmitter: 1.2 Kilowatt
- initial wavelength of HF radiation: 19 meters

b. Parasitic model used - protocol of experiment

The parasitic model in use was the acute trypanosomiasis of the mouse with *Trypanosoma equiperdum* (strain “of Pasteur Institute of Paris”).

Twenty mice were inoculated, each with  $2.0 \times 10^4$  parasites per mouse (antigenic type of base E1). Ten animals are not treated and are used as control group. The ten others are treated for 5 days, with a daily 12 hours session; the first session starts 2 hours after the infestation. The animals are placed in a plastic cage where the bottom is 12.5 centimeter away from the output face of the plasma tube.

c. Results of the experiment (that we will refer to with the term “Experiment A”) Figure 27 and Table III

- Control group: the animals all die between the 80th and 110th hour, presenting a massive parasitemia (T curve of figure 23). The evolution of the parasitemia, after an infestation with  $2.0 \times 10^4$  trypanosomes, has been shown at the top, in figure 11.

(Page 35)

- Irradiated animals: the evolution of the parasitosis in the treated animals can be broken down as follows:
  - / in certain animals (2 out of a total of 10), the radiation does not seem to have any effect (curve I1 of figure 27: the disease evolves exactly as in the control group).
  - / in other animals, the effect of the radiation is clearly noticeable. During the first three days of the disease, the parasitemia increases as in the control group and, around the 4th day, reaches a value close to  $11.0 \times 10^6$  parasites per microliter of blood. Two types of parasitemia evolutions are observed depending on the animal considered: i.e., an appreciable resumption, leading to death in the following days (3 mice out of 10 - curve I2 of figure 27), i.e., a progressive decrease leading to negativation that occurs around the 120th hour (5 mice out of 10 - curve I3 of figure 27).

If we continue the observation of the 5 negatived mice, we notice that the disease reappears again: the parasitemia turns positive again, from 4 to 7 days after the negativation, and the evolution toward death is reached within a few days (curve I’-3 of figure 27).

During these first experiments, the effect of the radiation thus proved to be extremely definite, but limited: the negativation occurs in 50% of the treated animals; but no animal is healed.

Many experiments of that type produced similar results.

We thus tried to vary, as far as possible, the properties of the emitted radiation. In fact, the only possible variable parameter was the HF radiation wavelength, and this for a simple reason: the rudimentary methods available to build the device did not permit to build it so that we could vary, at will and independently from each others, the various parameters (HF wave, UHF wave and magnetic field).

(Page 36)

However, to our great satisfaction, the variation of the HF wavelength proved to be beneficial. After multiple trial and errors, the choice was made to a wavelength of 17 meter.

Under these new conditions, the results obtained were much better. We redid experiments exactly identical to the precedent ones: same inoculum, same treatment conditions (we will refer to this experiment with the term "Experiment B" - figure 28 and table IV). We then notice the following facts:

- the parasitemia evolves here again, at first, appreciably as in the control group, but only until the 72nd hour.
- but afterward, the ten treated mice show a decrease of the parasitemia that ends in all cases with the negativation between the 90th and the 110th hour. So the treated mice are negativated at the time when the mice of the control group are dying (curve I of figure 28).

However, if we continue the observation of the negativated mice, we notice here again that between the 7th and the 10th day following the negativation, the animals show a relapse: the trypanosomes reappear in the blood and the parasitemia evolves toward death within a few days (curve I' of figure 28).

We have, in some rare cases (16 in total) increased the duration of treatment, until the 12th and even the 15th day; under these conditions, most of the animals (13 out of 16) did not show relapses and their study permitted to conclude to their healing.

## 1.2. - Irradiation experiments with device No 2.

At the end of 1968, we were able to use device No 2 with the following essential characteristics, compared with device No 1:

- magnetic field of 1200 Gauss at the output face of the tube (device No 1: 600 Gauss)
- power of the HF transmitter: 2 Kilowatt (device No 1: 1.2 Kilowatt)
- wavelength of HF radiation: 17 meter (device No 1: 19 meter then 17 meter)



(Page 37)

We redid experiments absolutely identical to the precedent experiments (same inoculum, same treatment conditions) but generally working on larger groups of animals.

The results of one of these experiments (that we refer to with the term “Experiment C”) are given in figure 29 and table V; they concern ten animals as control group and thirty treated animals. The results are somewhat different from those obtained with device No 1. Indeed:

- the parasitemia in the treated animals increases appreciably as in the control group, but during the first 50 hours only.
- after the 50th hour, we see a stall; the parasitemia remains almost stationary for approximately 20 hours, then it decreases rapidly and we see the negativation of all the animals (thirty out of thirty) between the 80th and the 90th hour after infestation (curve I of figure 29).

The effect of radiation thus seems stronger. Another finding points to the same thing. Indeed, although we observe the appearance of parasitic relapses in most of the negativated mice (twenty one out of a total of thirty) 4 to 10 days after the negativation (curve I of figure 29), an appreciable minority of mice (nine out of thirty) do not go into relapse. The mice were kept in laboratory for one year; the tests done afterward permitted to confirm their complete parasitological healing.

We can thus say that globally, the effect of device No 2 is stronger than the one of device No 1, at least on the model of acute trypanosomiasis, for the following reasons:

- on one hand, the parasitism does not get as high (less than  $1.0E5$  parasites per microliter of blood) and the negativation is done within a shorter time (80 to 90 hours).
- on the other hand, an appreciable proportion of mice were definitely healed.

(Page 38)

We thus adopted device No 2, and all the experiments described below were done with it.

Before to continue, we must point out an interesting fact and it will be mentioned in the Discussions chapter.

During the “Experiments of type C”, it is quite common to observe mice still showing a significant parasitemia at the end of the 4th session of treatment; this parasitemia keeps regressing, thus outside of exposure to the radiation, and the negativation can then occur before the beginning of the 5th session of treatment.

Another fact, of practical nature, must also be mentioned.

“Experiment C”, described above, was in fact repeated 5 times. The results obtained are quite superposable; however, differences in intensity exist. So:

- the stall, which generally occurs around the 50th hour (at the end of the intense multiplication phase) can sometimes occur earlier, around the 40th hour.
- moreover, the phase of stationary parasitemia is sometimes shortened, and even almost nonexistent, but always followed with a phase of rapid decrease.

Under these conditions, the parasitic negativation could sometimes be obtained before the 80th hour, even exceptionally as early as the 3rd day after infestation, between the 60th and 72nd hour (see “Experiment M” further below: influence of the distance of animals relative to the axis of the device).

These variations in intensity of the global effect of the radiation on the parasitic model are, in our opinion, essentially due to the fact that certain parts of our device can be in a more or less advanced state of wear (the transmitter tubes, for example); we must emphasize that this situation is imputable to the construction conditions of our device.

(Page 39)

We sought to narrow down the experimental conditions of the effect of the radiation. These conditions are, some linked to the radiation itself, some others linked to the parasitic model. To make this paper clearer to understand, we first address the latter.

(Page 40)

## 2 - ACUTE TRYPANOSOMIASIS WITH T. EQUIPERDUM: TUNING OF EXPERIMENTAL CONDITIONS LINKED TO THE PARASITIC MODEL

Most of the experimentation was done on the mouse, and this was for reasons of convenience (handling of animals, and possibility to treat more of them simultaneously).

### 2.1. - Duration of the daily irradiation

For the 3 precedent experiments (A, B and C), we were irradiating daily for 12 hours. We tried to reduce the exposure time.

For this, we did experiments (experiments that we will refer to with the term “Experiment D”), similar to the precedent experiment: inoculum of  $2.0E4$  parasites, treatment for 5 days, but with daily sessions of variable duration (5, 3 and 2 hours; 3 groups of 20 mice). The results are as follows:

- daily sessions of 5 hours produced as good results as those stated under the precedent experiment C: all the mice negativate themselves, and approximately one third of them proved to be definitely healed.
- daily sessions of 2 and 3 hours are insufficient: they do not succeed to stem the fatal evolution of the parasitosis.

For the rest of the experiments, the duration of daily sessions was fixed to 6 hours.

## 2.2. - Importance of the inoculum

We can ask ourselves what is the superior limit of the effect of the radiation, in other words, what is the maximum quantity of trypanosomes where the inoculation does not end with a mortal parasitosis with the help of the radiation.

(Page 41)

For this, we did experiments (that we will refer to with the term “Experiment E” - Figure 30) where the mice were infested with larger doses of trypanosomes ( $2.0E5$  and  $2.0E6$ ) and treated during 5 days (daily sessions of 6 hours, the first session starting 2 hours after the infestation).

For an inoculum of  $2.0E5$  trypanosomes, we note that the non-treated mice die within 70-80 hours, and that the treated mice show, for 50 hours, a phase of increasing parasitemia similar to the one in the control group; then the parasitemia remains at a plateau for approximately 20 hours, then decreases rapidly; the negativation comes around the 120th hour.

On the other hand, for an inoculum of  $2.0E6$  trypanosomes, the effect of the radiation is powerless to stem the evolution of the mortal acute parasitosis; we simply observe a delay of approximately 10 hours.

Under the current situations, the superior limit of the effect of the radiation thus seems to be the following: the possibility to stem and even to heal an acute trypanosomiasis in the mouse infested with  $2.0E5$  trypanosomes, a dosage that irremediably provokes the death of all mice within 80 to 90 hours.

## 2.3. - Importance of the time of the start of treatment

In short, this concerns studying the effect of the radiation on the acute trypanosomiasis of the mouse that has evolved for a certain time.

For this, experiments similar to those described above (see above, same chapter, paragraph 2.1) are done but the first of the 5 sessions of irradiation occurs respectively after 24, 48 and 72 hours of evolution of the disease (we refer to those experiments with the term “Experiments F” - Figure 31).

The mice where the treatment started 24 hours after infestation behave quite like the mice treated immediately. Simply, the stall, compared with the evolution of the parasitemia in the mice of the

control group, occurs slightly later, around the 60th hour; thus the parasitemia reaches a slightly higher maximum;

(Page 42)

but the negatigation also occurs between the 90th and the 110th hour.

In the mice placed under treatment 48 hours after their infestation, we noted somewhat different results depending on the experiments. In certain experiments, all the mice succeeded to shake off their parasitosis; in other experiments, the stall and the negatigation occurred later (around the 70th hour for the former, between the 120th and the 130th for the latter).

In the mice placed under treatment 72 hours after the infestation, the parasitemia is about  $1.0 \times 10^6$  trypanosomes per microliter of blood at the time where the treatment starts: the evolution ends with death, just as with the control group.

We stated in the precedent chapter (see paragraph 4.1.1.) that when the mouse dies of acute trypanosomiasis with *Trypanosoma equiperdum*, its spleen was increased in size: it often weighs 250 to 300 milligrams (while the normal weight is around less than 100 milligrams). Thus, we wanted to study the effect of the radiation on mice without spleen.

#### 2.4. - Influence of preliminary splenectomy

We did an experiment (that we refer to with the term “Experiment G”) involving 3 groups of 15 mice: 1 group of non-treated mice as control, 1 group of treated normal mice, and 1 group of treated mice splenectomized 24 hours before the infestation. The other conditions are the same as those of the experiments described above (see experiments of type D). The results do not show much differences for the effect of the radiation, whether the mice have a spleen or not.

#### 2.5. - Behavior of the dyskinetoplastic strain (Bethesda) of *Trypanosoma equiperdum*

All the experiments described above (Experiments of types A, B, C, D, E, F and G) were done with the strains called “from Pasteur Institute of Paris”. We can, of course, ask ourselves whether

(Page 43)

another strain of *Trypanosoma equiperdum* could have its evolution interrupted in the mouse under the effect of radiation emitted from our device. Thus we did experiments with the dyskinetoplastic strain (experiments that we refer to with the term “Experiment H”).

The results show that the effect of the radiation on the acute trypanosomiasis of the mouse, due to this dyskinetoplastic strain, is exactly the same as the one described for the acute trypanosomiasis of the mouse due to the strain called “from Pasteur Institute of Paris”.

#### 2.6. - Influence of the total duration of treatment (Number of irradiation sessions)

All the experiments described so far involved a 5-day treatment, with a daily session of irradiation of 12 hours or 6 hours. This 5-day duration was initially selected for reasons that concerned economics: the cost of the electrical consumption. Yet afterward, we asked ourselves if there was a need to increase this duration of treatment.

We thus doubled the total duration of the treatment: 10 days instead of 5. The other conditions remained the same (inoculum of  $2.0E4$  parasites; duration of daily irradiation sessions of 6 hours, the first session starting 3 hours after infestation).

Four experiments of that type were done, each involving 30 treated mice and 10 non-treated mice as control. We refer to these with the term "Experiment of type I".

We can compare the result of these experiments to those obtained during the experiments of type D that involved only 5 irradiation sessions of 6 hours.

We then note that a treatment of 10 days increases considerably the proportion of definitely healed mice: these reached, depending on the experiments, 90 to 100% of the animals (instead of approximately 30% for Experiments of type D).

Finally, among the healed mice, a behavior quite unexpected was observed in some rare cases (in three mice from a

(Page 44)

total of twenty treated during Experiments of type I). The 8th day after the negativation comes a relapse, but the parasitemia remains moderate (around  $1.0E3$  to  $1.0E4$  parasites per microliter of blood) and above all, it is ephemeral: it disappears after 2 to 3 days of evolution; the final healing then occurs.

## 2.7. - Results obtained in the rat

Many experiments of type D (5-day treatment, with a daily irradiation of 6 hours) and of type I (treatment of 10 days with a daily irradiation of 6 hours) were done in the rat; the inoculum however was of  $2.0E5$  parasites: indeed, such an inoculum provokes, in the non-treated rat, a parasitosis evolving quite like the one obtained in the mouse inoculated with  $2.0E4$  parasites (Figure 11).

The results obtained during these experiments are absolutely similar to those described above in the mouse.

We will see later (see below at paragraph 4.3.4) that the rats, healed by the radiation, permitted to reveal an interesting phenomenon to understand how the radiation works: the therapeutic facilitation.

We must now talk about an important experimental condition, condition which still interests the parasitic model but which in someways helps to make the transition to the following paragraphs (the experimental conditions linked to the radiation).

## 2.8. - Body temperature of mice treated by the radiation

During the operation of the device, the ambient temperature did not rise near the active zone of emitted radiations and remained equal to the laboratory temperature (22 to 25 degree Celsius).

Normal mice were exposed to the radiations in the usual conditions of irradiation (distance of 12.5 centimeter relative to the output face of the plasma tube; duration of irradiation of 6 hours).

(Page 45)

The body temperature, which is about 37.2 +/-0.4 degree Celsius before the exposure, did not show any elevation.

Such a confirmation was indeed expected considering the energy radiated by our device, in particular the energy associated to the wavelength of 9.4 GHz. For this wave, the average energy density  $W_m$  is indeed equal to 10 microwatt per square centimeter (see above, paragraph 1.2). It is thus useless to point out that such a low average power cannot produce any global thermal effect in irradiated animals.

We nonetheless wanted to find out if an elevation of body temperature could affect the evolution of the acute trypanosomiasis of the mouse with *Trypanosoma equiperdum* (experiment that we refer to with the term "Experiment J"). For this, we placed mice infested with 2.0E4 parasites, 6 hours per day, at ambient temperatures respectively of 27 and of 37 degree Celsius. At 37 degree Celsius, the body temperature of mice increases by approximately 1.5 degree Celsius above normal.

In spite of this hyperthermy, caused in some way passively, we did not see any change in the evolution of the acute trypanosomiasis; the mice died around the 90th hour, sometimes even slightly earlier. Thus, it does not produce any slowing trend of the parasitosis.

(Page 46)

## 3 - ACUTE TRYPANOSOMIASIS WITH T. EQUIPERDUM: TUNING OF EXPERIMENTAL CONDITIONS LINKED TO RADIATION

Following the precedent experiments, the experimental conditions, linked to the parasitic model, could be determined. We then decided to practice experiments of type D or I (inoculum of 2.0E4 parasites; treatment of 5 or 10 days, with a daily irradiation session of 6 hours, the first session starting 2 hours after the inoculation) to study some experimental conditions linked to the radiation of device No 2. Here again, we must say that we were not able to do all the experiments that we wanted, the device not always being in operating order.

In a first time, we sought to study the influence of certain parameters of the emitted radiation. For that, we had to do experiments during which the animals were at variable distances, as much from the output face of the plasma tube than relative to its axis.

### 3.1. - Influence of the distance relative to the output face of the plasma tube

This experiment amounts to studying the effect of the emitted radiation according to the distribution of certain parameters along the axis of the tube (magnetic field and UHF radiation).

For this, an experiment was done (that we refer to with the term “Experiment K”) on 3 groups of twenty mice inoculated under the usual conditions (2.0E4 parasites), the first non-treated group is used as control group; the two other groups are treated, one at the usual distance of 12.5 centimeters (see the “Experiment A and following”) and the other at double the distance, i.e., 25 centimeters.

The control mice die with the usual symptoms.

(Page 47)

We note that the effect of the radiation is the same in the 2 groups of treated mice; the negatigation and the healing occur as during “Experiments of type C and D”.

Yet, we must point out that at a distance of 25 cm, the magnetic field is down to approximately 700 Gauss, while it is approximately 850 Gauss at a distance of 12.5 centimeters (Fig 6). It would be necessary to redo such experiments with the aim to figure out the maximum distance beyond which the effect of the radiation shows a decrease.

### 3.2. - Influence of the distance relative to the axis of the plasma tube

This amounts to studying the effect of the radiation in a plane perpendicular to the axis of the tube, but at various distances relative to that axis. Under these conditions, two essential parameters of the radiation vary:

- the magnetic field, which is constant until approximately 8 centimeters of the axis of the tube and decreases rapidly afterward.
- the UHF field, which on the other hand decreases rapidly when we distance ourselves from the axis of the tube.

We indicated above (see in chapter EQUIPMENT AND METHODS, paragraphs 1.2 and 1.4) the values of these two parameters, measured in a plane perpendicular to the axis of the plasma tube and distant of its output tube respectively by 4.2 centimeters for the magnetic field (Figure 7) and by 5 centimeters for the UHF field (Figure 4).

Let us point out that in our experiments, the mice are in a plane distant by 12.5 centimeters.

Let us point out also that the radius of the circular output face of the tube is 12 centimeters.

During the many experiments, we noticed that the active zone of radiation had, at 12.5 centimeters of distance from the tube, a radius of approximately 20 centimeters; the active zone thus seemed to have an area quite larger than the output face of the plasma tube. This observation permitted us to treat simultaneously up to 40 animals. However, an important fact, the animals were able to move

(Page 48)

freely on the surface of the cage (of 20 centimeters of radius).

We tried to study more precisely the influence of the distribution (relative to the axis of the tube) of the 2 essential parameters that are the magnetic field and the UHF field. We thus did experiments where the animals were placed in a series of cages, more or less distant from the axis of the tube.

To do this, it was advisable to make animal cages out of conductive metal, and for the walls and also the partitions; we chose brass. Under these conditions, the animals were subjected to the direct UHF wave, but not to omni-directional waves (as it would have been the case by using plastic). The power of the UHF wave at different lodges of the cage varies according to the distribution of the wave itself (Figure 4).

A first experiment (Experiment L) was done by using a rectangular cage (80 centimeters long by 8 centimeters wide). The cage is divided in 10 square lodges (8 centimeters by 8 centimeters), according to the diagram of figure 32.

This cage is laid out along the diameter of the tube.

Each lodge receives three mice, each infested with  $2.0E4$  parasites. The treatment consists in 5 days of irradiation, with a daily session of 6 hours, the first session starting 2 hours after the infestation.

For the animals placed in the 4 central lodges, the effect of the radiation is done according to the usual protocol (negativation between the 80th and 90th hour).

For the animals of the 6 peripheral lodges, the parasitosis evolves just as in non-treated control animals (the animals die between the 90th and 110th hour).

It thus appeared that the active zone of the device has a radius of 16 centimeters.

(Page 49)

During this experiment, the evolution of the parasitemia was done with the semi-quantitative technique (see above chapter Equipment and Methods, paragraph 5.2.1). It appeared nonetheless that the effect of the radiation could be linked to distributions of UHF power. To obtain quantitative data, we were brought to do a somewhat different experiment.

For this experiment (that we refer to with the term "Experiment M"), we increased the number of animals per lodge, in order to obtain a more accurate average value of the parasitemia; then we quantified, with a narrower step, the levels of UHF power. For this, ten circular coaxial lodges (lodges No 7 to No 10) or semicircular (lodges No 1 to No 6) were designed (Figure 33). The spacing of the walls is 4 centimeters. Each lodge receives ten mice, inoculated with  $2.0E4$  parasites, except the central cylindrical lodge (No 10) which receives only two mice and the annular lodge (lodge No 9) which receives only four mice.



The treatment involves 5 days of irradiation, with a daily session of 6 hours, the first session starting 2 hours after the infestation. The parasitemia was measured with the help of the quantitative technique (2 numerations per day).

The results of the precedent experiment (Experiment L) were confirmed (Figure 34).

The effect of the device is used with the usual protocol (see curve of Experiment of type C, Figure 29) on the 4 central lodges. In this experiment, the negativation of the parasitemia even occurred earlier (around the 60th hour).

The mice, placed in the peripheral lodges No 1 to No 5, all die of acute trypanosomiasis, under the same conditions as the non-treated control mice.

The ten mice of the lodge No 6 have an intermediate behavior: eight mice recover (the negativation occurs around the 80th hour thus later than for the mice in the 4 central cages No 7 to No 10), but two evolve toward death. They die however with a delay of approximately 12 hours compared with non-treated control animals.

(Page 50)

There thus appears to be a real correlation between the biological effect and the level of UHF power. For the 10 different lodges, these levels of power are the following (average radiated power):

0	microwatt for lodges No 1 to No 5
22-95	microwatt for lodge No 6
095-220	microwatt for lodge No 7
220-440	microwatt for lodge No 8
440-650	microwatt for lodge No 9
650-700	microwatt for lodge No 10

In analyzing all the data of the evolution of the parasitemia in the mice of the 10 lodges, Berteaud et al. (8) went on with a mathematical approach; they introduced the notion of “average rate of the evolution of the parasitemia”: the decrease of this “average rate of the evolution of the parasitemia”, i.e., the effect of the radiation, would be proportional to the power of the UHF wave.

In practice, and in operating with the selected parasitic model (acute trypanosomiasis of the mouse with *Trypanosoma equiperdum* - inoculum of  $2.0E4$  parasites - treatment established almost immediately and involving 5 sessions of irradiation of 6 hours), we can define the active zone of the device:

- up to a distance of 16 centimeters relative to the axis of the tube, the negativation of the parasitemia is obtained in 100% of the cases.
- from 16 to 20 centimeters, the effect is not constant anymore and some of the mice develop an acute trypanosomiasis.

- beyond 20 centimeters, the effect is nil.

Although the necessity of the UHF wave of 9.4 GHz may be clearly demonstrated, these results do not mean that this [UHF] radiation is sufficient by itself. We know, besides, that the UHF wave is a carrier for the HF wave (17 MHz).

We thus did experiments aiming to show the eventual synergy of the essential constituents of the radiation.

(Page 51)

### 3.3. - Synergy of the essential constituents of the radiation

Many experiments (often involuntary experiments, the results of equipment failures) proved that the suppression of one of the 3 main constituents of the radiation cancels the biological effect of the radiation, at least on the parasitic model used.

Some experiments were redone, during which we suppress individually:

- either the HF field (wavelength of 17 meters)
- either the UHF field (wavelength of 3 centimeters)
- either the rotation of the rotating anode

In these 3 experiments (that we refer to with the terms “Experiments N, O and P”), the biological effect was absolutely nil.

The synergy of the 3 main constituents thus appears to be absolutely necessary. We must however keep in mind that it is not possible, under the current conditions, to suppress one of the constituents without changing the characters of the other two constituents.

We were equally able, with the help of a specific setup, to study the effect of the UHF wave (we refer to this experiment with the term Experiment Q”). A waveguide splitter brought the isolated UHF wave to the animals. We were thus able to treat simultaneously 2 groups of mice:

- a group No 1 with the usual radiation involving the 3 main constituents.
- a group No 2 with the UHF wave alone.

We ensured that the power of the UHF radiation (average radiated power) was identical for the 2 groups of mice (95-220 microwatt at the periphery of the cages, 650-700 microwatt at their center).

(Page 52)

The mice of group No 1 all negativate themselves in the usual conditions (see curve of negatvation of an Experiment of type C). The mice of the group No 2 die of acute trypanosomiasis just as the non-treated infested control mice.

This experiments show that the UHF wave, if it is necessary, is not sufficient by itself to insure the effect of our device on the acute trypanosomiasis of the mouse with *Trypanosoma equiperdum*.

A simple modification of one of the constituents can even change the effect of the radiation on the parasitic model. We will give an example.

#### 3.4. - Influence of the nature of the magnetron

Usually, we used, in our device, magnetrons of brand "Raytheon". Yet for one experiment (that we refer to with the term "Experiment R"), we had to use a magnetron of a different brand, "Thomson". It was a normal experiment of type D (inoculation of  $2.0E4$  parasites - treatment involving a daily session of irradiation, of 6 hours during 5 days).

The biological results were clearly less favorable. Indeed, on thirty mice treated, only twenty-three negativate themselves, around the 90th hour. The seven others evolve toward death, which occurs with a delay of approximately 15 hours compared with the non-treated mice. Under the usual conditions (use of a "Raytheon" magnetron), the negatvation occurs in all the mice.

This result is very interesting because what distinguishes the two types of magnetrons is essentially their internal voltage during the operation of the device: 4 kilovolts for the "Raytheon" magnetron and 15 to 20-kilovolt for the "Thomson" magnetron.

#### 3.5. - Effect of accessory constituents of the radiation

We did a normal experiment of type D, interposing a black paper between the output face of the tube and the cage

(Page 53)

of the animals, with the aim of suppressing the constituents of the visible and infrared spectrum. We refer to this experiment with the term "Experiment S".

The biological effect of the radiation on the parasitic model is completely preserved.

(Page 54)

### 4 - MICE AND RATS INFESTED WITH T. EQUIPERDUM: STUDY OF THE IMMUNE STATUS OBTAINED WITH THE HELP OF TREATMENT BY IRRADIATION

The study of the immune status can be done on mice (or on rats) having been subjected to experiments of type D or I, which involve treatments of 5 or 10 days respectively. We saw that we obtained the negatvation of all the mice during such experiments. This study of the immune

status can be done at the 3 levels suggested in the chapter Equipment and Methods (paragraph 5.3), namely:

- the serous level of G and M immunoglobulins
- the study of the evolution of the 4 selected humeral antibodies
- the study of the state of the immune protection

#### 4.1. - Serous levels of the IgG and the IgM

The levels of the IgG remain quite constant, before and after the treatment.

On the other hand, the study of the level of the IgM is interesting: as early as the negativation of the parasitemia, this level increases moderately (6 to 8 times the normal level) and this increase persists for 8 to 10 days. There is a stimulation, moderate but definite, of the immunocythes synthesizing the IgM, as in a trypanosomiasis of long duration.

#### 4.2. - Evolution of the humoral antibodies

The titer of the four humoral antibodies appears relatively low. Thus the titer of the agglutinants antibodies is of the order of 200 to 400, the one of the hémagglutinants antibodies of the same order, and the one from precipitants antibodies vary from 1/3 to 1 (the meaning of these values was shown above at the chapter Equipment and Methods, paragraph 5.3.3).

The sero-protective antibodies are barely detectable, at least with the first technique used: the analyzed serum diluted to 1/10 (that is the first

(Page 55)

dilution that we inject to the test mice), provides only a partial protection.

We need however to nuance these results and it is in the light of facts that we observed and which will be exposed later below (see below, same chapter, paragraph 5.6).

However, this low value, at least in appearance, of the antibodies titers contrasts with the strength of the state of immune protection created in the negativated mice.

#### 4.3. - Study of the state of immune protection - Reinfestation

This state of immune protection can be proved in all treated animals, in those that healed and in those that showed relapses.

##### 4.3.1. - Mice having presented fatal relapses

The analysis of the antigenic types isolated from the host-organism, during relapses, shows that these types are always different of the inoculated basic type E1.

This means that the state of protection, which settled in after the negativation under the effect of radiation, prevents the recolonisation of the organism by the antigenic type of base E1 and has for consequence the “variation” of a parasite, in particular concerning some of its antigenic structures. It thus seems that the state of immune protection is very specific to antigenic type, which is classically admitted.

4.3.2. - Mice having evolved toward the healing but after a parasitemic, moderate, and temporary relapse.

The analysis of the antigenic types present in the mouse during the relapse shows the same result: it is always different of the type E1.

There again, we can say that the state of immune protection obtained is specific to the antigenic type that has induced it (in occurrence, the type E1), but we must admit that in this case, its specificity

(Page 56)

is not absolute since it acts also in an efficient manner toward an antigenic type different of type E1.

The animals are healed and we can study their state of immune protection more in depth.

4.3.3. - Mice having evolved directly toward healing

To test the merits of the state of immune protection, we must do reinfestations with trypanosomes of basic type E1 (the reinfestation with a different antigenic type provokes an acute trypanosomiasis).

The healed mice that will be mentioned in the experiments of reinfestation are considered healed, although in theory not satisfying all the criteria for healing (inoculation of ground up organs of different types to normal mice). In practice, however, we can be certain of the healing: the parasitemia, regularly monitored, remains constantly negative (transfer of blood from the animal to normal mice).

Different types of experiences involving reinfestations were done, depending on the number of reinfestations and the sizes of the infesting doses.

./ First experiment (that we refer to with the term “Experiment T”)

.....

Mice are inoculated and treated according to the usual protocol (see Experiment I). We keep the healed mice and divide them in three groups of twenty animals. These groups are infested (with an inoculum of  $2.0E4$  parasites), respectively at the end of 6 months (for the group No 1), of 12 months (for the group No 2) and of 18 months (for the group No 3). Some animals died in the mean time from intercurrent affections.

The results show that an important proportion of mice resist to reinfestation:

- 8 out of 10 in the group No 1
- 6 out of 9 in the group No 2
- 3 out of 7 in the group No 3

(Page 57)

The persistence of the state of immune protection is thus remarkable. It persists even in the mice that do not resist to reinfestation: the trypanosomes that evolve in that case belong to an antigenic type different of type E1.

In the mice that resist to the reinfestation, we note an interesting fact: the titer of the humoral antibodies increases considerably; so, in the surviving mice of the three precedent groups, we observed the following maximal titers:

Antibodies	Titer
-----	-----
Agglutinants	5,000
Hémagglutinants	20,000
Precipitants	2
Sero-protective	50 and 100

N.B.: For the sero-protective antibodies, the first number shows the titer corresponding to a total protection, the second shows the titer corresponding to a partial protection (see above, in the chapter EQUIPMENT AND METHODS, the paragraph 5.3.3.e.)

In the same mice, the state of immune protection becomes particularly intense. We were thus able to, one month later, reinfest these mice a second time, but with an infecting dose very superior to usual doses:  $2.0E8$ . On the seventeen mice, seven could resist to that large inoculum; the ten others get an acute trypanosomiasis, but of antigenic type different of the basic E1 type.

Other experiments involving multiple infestations were done, by varying the size and the rhythm of reinfestations.

./ Second experiment (that we refer to with the term "Experiment U")

.....

We take healed mice after inoculation and usual treatments (see Experiment I) and we divide them in 3 groups of twenty mice that are regularly reinfested, but according to different rhythms: every 10 days (for the group No 1), every 30 days (for the group No 2) and every 90 days (for the group No 3). The reinfestations are all done with  $2.0E4$  parasites.

(Page 58)

Here are the results:

- For the group No 1, and as early as the 3rd reinfestation, most of the animals do not succeed to resist to the infesting dose and develop an acute trypanosomiasis (at antigenic type different of basic E1 type): after the 4th reinfestation, all the mice of the group are dead of acute trypanosomiasis.
- for the group No 2, the phenomena are similar, but with one small difference: it is the 5th reinfestation which is fatal for seventeen mice; the three others die after the 6th reinfestation.
- For the group No 3, on the opposite hand, the protection proves to be excellent: the 7th (and last) reinfestation (the mice are then close to 2 years old) is still overcome by all the animals.

These results thus show clearly that reinfestations that are close in time, not only do not improve the state of immune protection of mice, but, on the contrary, bring a break of that state.

We note in the mice of group No 2 and No 3 some interesting phenomena concerning the serous level of immunoglobulins G and especially M. The IgG increases moderately (2 to 3 times the normal level) from the first reinfestations. The IgM increases equally, usually after the 3rd reinfestation; but this increase has a particular characteristic: it is not regular, as a ceiling level (as during a trypanosomiasis of long duration) but in seesaw (rhythmed from the reinfestations) the maximal values can be important, up to 20 times the normal level (53).

The titers of the humoral antibodies are elevated in these mice, in particular in those of the group No 3. We noted the following maximal values:

Antibodies	Titer
-----	-----
Agglutinants	20,000
Hemagglutinants	80,000
Precipitants	16
Sero-protective	50 and 100

(page 59)

4.3.4. - State of immune protection in the rats infested by T. Equiperdum and treated by the radiation. Phenomena of therapeutic facilitation.

We did an experiment identical to Experiment T but with inoculums (infestation and reinfestations) of 2.0E5 parasites (experiment that we refer to with the term "Experiment V").

All the rats presented a state of total resistance.

The study of the state of immune protection in the rat permitted to reveal a particular phenomenon, certainly very important for the comprehension of the mechanism of the effect of the radiation.

This phenomenon was observed during the experiment (that we refer to with the term "Experiment W"). Rats are infested with  $2.0E5$  parasites and treated according to the habitual conditions (10 days of treatment with a daily seance of 6 hours). We were thus able to retrieve 4 rats, which around the 12th day after the infestation, presented a severe relapse, normally evolving toward death. When the parasitemia was about  $1.0E5$  parasites per microliter of blood), we did a single session of treatment (of 6 hours). The parasitemia decreased rapidly and became nil; the animals healed.

In this case, a single session of treatment thus sufficed to stop a strong parasitosis, already well installed and normally evolving toward death. Everything happens as if the immunity protection, induced by the first treatment, and theoretically specific to base type E1, did greatly help the effect of the radiation on the evolution of an antigenic type different of type E1.

Concerning the acute trypanosomiasis of the mouse (and rat) with *Trypanosoma equiperdum*, we can thus say that the effect of

(Page 60)

the radiation can:

- interrupt, in 100% of the cases, the evolution of the experimental disease (negativation of the parasitemia).
- bring the definite healing of a certain proportion of animals, proportion that is variable according to the conditions of treatment.

During the healing, the immune status is very satisfactory, in particular the state of immune protection.

(Page 61)

#### 5 - CHRONIC TRYPANOSOMIASIS OF RABBIT WITH T. EQUIPERDUM EFFECT OF RADIATION

We decided to study the effect of radiation on twenty-five rabbits infested with *Trypanosoma equiperdum*.

The experimental conditions were essentially of two categories, according to whether the treatment by irradiation had been started either 2 hours after the infestation, or either started after a certain evolution period of the disease (two, three and four weeks).



This irradiation treatment is more intensive than the one used for the acute trypanosomiasis of the mouse or rat: the daily sessions of irradiation are longer (10 hours instead of 6) and the total duration of the treatment could reach three weeks.

We said in the chapter Equipment and Methods (paragraph 4.2.1.a) that the infestation is always done with a considerable number of trypanosomes, belonging to the antigenic type of base E1:  $5.0E6$  to  $2.0E8$ ; the amount of the inoculum does not seem to affect the evolution of the disease.

For each experiment of treatment by irradiation, three rabbits infested under the same conditions, but non-treated, served as control group. The control rabbits (twenty-one in total) always presented a chronic trypanosomiasis leading to death within 5 to 10 weeks in a very stereotyped manner; this evolution was also described at paragraph 4.2.1.a.

#### 5.1. - Effect of the treatment by irradiation started 2 hours after infestation.

Five rabbits were treated under these conditions; the treatment involved either 8, or either 10 sessions of irradiation, of 10 hours each. Here, we give the results concerning one of these rabbits (Rabbit RQ80 - figures 35 and 36), but the phenomena observed in the four other

(Page 62)

rabbits are absolutely superimposable, with a small difference concerning the parasitemia that will be addressed below in this paragraph (we refer to this experiment with the term "Experiment X".)

The clinical state remains quite normal. The parasites are absent from the peripheral blood.

On the biological point of view, we note otherwise a rapid decrease of the albumin/globulin ratio; this decrease, which is maximal on the 8th day after infestation, is only temporary: the ratio returns to normal approximately 4 weeks later.

The serous level of immunoglobulins increases slightly, in particular the IgM level (twice the normal rate).

Finally, the irradiated animal also develops humoral antibodies; their titer is quite moderate, but they continue to be developed for many months.

The persistence of humoral antibodies, and also the decrease of the albumin/globulin ratio and the slight increase in the serous level of IgM lead us to believe that the effect of the radiation is not instantaneous: everything happens as if a slight parasitosis developed for a few days.

This way to see things could be confirmed in two other rabbits treated under the same conditions and in which a parasitemia still existed 5 days after the infestation; this parasitemia was extremely low: the transfer of 0.5 milliliter of blood to normal mice did not regularly provoke an acute trypanosomiasis and we can thus think that the parasitemia was of the order of some parasitic units per microliter of blood. Afterward, the parasitemia definitely remained negative.

Finally, when the total duration of the treatment is inferior to 6 days, the effect of the radiation proves to be insufficient to prevent the evolution of a trypanosomiasis.

(Page 63)

## 5.2.- Effect of treatment by irradiation started after a certain time of evolution of the disease.

### 5.2.1. - Evolution of the disease for 2 weeks.

Two weeks after infestation, the clinical and biological problems are already quite evident. The parasitemia is permanently positive. The albumin/globulin ratio is very low (down to 0.5 or even less). The increase of the serous level of IgM is every time very significant (from 6 to 16 times the normal value); the increase in the serous level of IgG is more inconstant and more variable (see chapter Equipment and Methods, paragraph 5.3.1.c).

The treatment lasts 15 days with a daily session of 10 hours. Two rabbits were treated this way. Figures 37 and 38 show the results for one of them (Rabbit RQ 85 - we refer to this experiment with the term "Experiment Y").

The effectiveness of the treatment is visible from the first days. The general state improves, the oedematous signs disappear from the muzzle and the ears (which straighten up again). The evolution occurs toward a clinical healing within 10 to 15 days (figure 39). The testicular lesions regress and evolve toward healing (the histological phenomena are described in the next paragraph 5.3).

On the biological aspect, the results are as follows:

- the parasitemia negativates itself after a few days and definitely remains negative.
- the albumin/globulin ratio normalises itself with a few weeks.
- the level of IgM normalizes itself very rapidly; it decreases approximately by half within 10 days: everything happens as if the treatment immediately blocked the deployment of the IgM molecules linked to the evolution of the parasitosis.
- the level of IgG, for which the increase is generally less, normalizes itself more slowly; but we know that the variations of this immunoglobulin do not strictly correspond to an evolutive disease.
- the titer of the hemagglutinants and precipitants remains high and this, for a very long time (the observation of rabbit RQ 85 was

(Page 64)

stopped after approximately one year).

- the titer of the agglutinants antibodies of antigenic anti-type of base E1 decreases, just as it decreases in non-treated animals.

### 5.2.2.- Evolution of the diseases for 3 weeks

The pathological problems are even more evident. It was necessary to start an anti-allergenic treatment (based on antihistamines and vitamin C), in same time as the irradiation, otherwise the animal dies of anaphylactic shock, linked most likely to the destruction of the parasites.

The treatment lasts 21 days with a daily session of 10 hours. Two rabbits were treated that way (we refer to this experiment with the term “Experiment Z”).

The evolution also goes toward healing, but more slowly.

#### 5.2.3. - Evolution of the disease for 4 weeks.

Two rabbits are treated under these conditions (we refer to this experiment with the term “Experiment AA”).

The effect of the radiation cannot prevent a mortal evolution of the parasitosis anymore: the organic lesions are too important, and the clinical state of the animals is close to cachexy.

Concerning the chronic trypanosomiasis of the rabbit with *Trypanosoma equiperdum*, we can then state that the effect of the radiation:

- prevents the development of the disease, if started 2 hours after the infestation.
- cures the disease that settled in, if the treatment occurs before the 4th week. That is a remarkable result.

Finally, humoral antibodies persist in the healed animals (hemagglutinants and precipitants) for many months and at an elevated titer. This attests to the good operation of the immune system and thus to the absence of noxious effects on this [immune] system coming from the radiation.

(Page 65)

When we presented the results of the effect of the radiation on the acute trypanosomiasis, we mentioned the necessity for the simultaneous presence of three essential constituents (UHF wave, HF wave and magnetic field). The same goes concerning the effect of the radiation on the chronic trypanosomiasis of the rabbit with *Trypanosoma equiperdum*. We were able to verify this during certain breakdown of the device that, at certain times, suppressed such or such essential constituent of the radiation; under these circumstances, the usual evolution of the disease was not affected at all.

#### 5.3.- Histological study of the testicular lesions and of their evolution in rabbits treated by irradiation.

This study was conducted in collaboration with Professor G. Mayer (Histology and Embryology Laboratory - Medical Sciences Unit III - Bordeaux) and it was also done for two different experimental circumstances: treatment started 2 hours after the infestation and treatment started after 15 days of evolution of the chronic trypanosomiasis (45).

##### 5.3.1. - Treatment started 2 hours after the infestation

Two rabbits were studied under these conditions; the treatment, started 2 hours after the infestation, lasted 10 days, with a daily session of irradiation of 10 hours (see same chapter, paragraph 5.1).

The testicles were collected 30 days after the infestation, i.e., 20 days after the treatment stopped. The histological examination reveals that the glands are in an absolutely normal state, both their exocrine part and their endocrine part.

This confirms what was stated above (see same chapter, paragraph 5.1): if it is possible that a very slight and very temporary parasitosis evolved during the few days that followed the infestation, it still does not leave any histological trace in the testicles 30 days later.

(Page 66)

#### 5.3.2. - Treatment started after two weeks of evolution of the disease

Four rabbits were studied under these conditions; the treatment lasted 15 days, with a daily session of irradiation of 10 hours (see same chapter, the paragraph 5.2.1.). On the 15th day of the disease, the histological lesions of the testicles are considerable.

For two rabbits, the testicles were collected 30 days after the infestation (i.e., at the end of the treatment period). At that time, lesions that are quite noticeable still exist. The seminal tubes are smaller in size, but they are not entirely depopulated of germinal cells; among these, the involute forms are numerous. The interstitial gland is involute. The lymphocytic infiltration of the inter-tubular conjunctive tissue is more or less abundant. The epithelium of the epididymal tubes is cubic; the openings of the tubes do not contain any spermatozoids.

For the two other rabbits, the testicles were collected later:

- on the 44th day after the infestation, i.e., 2 weeks after stopping the treatment, the lesions are still visible; the spermatozoids are still absent in the openings of the seminal tubes, but the epithelium has returned to a palissadic form, which attests to the recovery of the endocrine function (figure 40).
- In the 8th month after the infestation: the histological aspect is absolutely normal, as much for the testicles as for the epididymis; the exocrine function is normal: put in presence of a female rat at the 7th month, the rabbit proved to be fertile and was the source of an apparently normal litter (figure 41).

It thus appears that we can state that in the trypanosomed rabbit (and where the disease has been evolving for 15 days), the effect of the radiation permits to obtain the healing of testicular lesions, with regeneration of glandular tissues (exocrine and endocrine) and recovery of their functions. The achievement of this healing requires a certain time, which is quite logical after all.

(Page 67)

#### 5.4. - Body temperature of rabbits during the treatment

We mentioned that feverish bursts to 40-41 degree Celsius occurred during the chronic trypanosomiasis of rabbit with *Trypanosoma equiperdum*. These bursts are irregular and nothing permits to explain the rhythm of their appearance (there does not exist, in particular, any detectable variations of the parasitemia).

In the treated rabbits, we can observe such feverish bursts during the first 5 days. Afterward, the temperature remains strictly normal (38.5-38.8 degree Celsius).

The initial phase (feverish bursts during the first 5 days) exists also in the infested animals where the treatment is started immediately. This fact favors the existence, under such experimental conditions, of a slight and temporary parasitosis that then evolves rapidly toward healing (figure 42).

Anyway, we can thus state that:

- the hyperthermy that exists in the non-treated trypanosomed rabbits does not allow the animals to get rid of their parasitosis.
- the treatment by radiation, on the other hand, quickly brings a normalization of the temperature in same time as the healing occurs.

A fact again corroborates these findings: the healing of the testicular lesions. Their healing indeed implies the normalization of body temperature of the animals. We know that the hyperthermy brings an important involution of the gland in testicles. Such an hyperthermy can be achieved with a normal rabbit, without any infectious process, by placing the testicles into an intra-abdominal position.

(Page 68)

#### 5.5.- Trypanosomed rabbits healed by the radiation: effect of a reinfestation not accompanied by irradiation

We saw that the rabbits, infested with *T. Equiperdum* and healed by the radiation, develop humoral antibodies in a prolonged manner. The titers of these antibodies are particularly high in the cases where the animals are placed under treatment after 2 to 3 weeks of evolution of the trypanosomiasis. We thus wanted to study the state of immune protection of these rabbits by doing reinfestations.

We noted right away that the reinfestations were always followed, within a few weeks (5 to 12 weeks), by the appearance of a mortal evolution of parasitosis; seven rabbits were studied this way (experiments that we refer to with the term "Experiment of type AB").

Thus the state of immune protection is not total, but we will see in the next paragraph that it exists nonetheless.

We must also point out that the reinfestations were always done with important doses of trypanosomes:  $5.0E6$  to  $2.0E8$  (just like the infestations). And it is permitted to believe that the animals would perhaps have resisted to lesser reinfesting doses.

#### 5.6.- Trypanosomed rabbits healed by the radiation: effect of reinfestations accompanied by irradiations

We soon realized that rabbits, infested with *T. Equiperdum* and healed by a first treatment of irradiation, were capable to resist reinfestations with the condition that those be accompanied of a new irradiation, even much reduced, that is namely 2 or even only 1 session of 10 hours. We are here again in presence of a phenomenon of therapeutic facilitation, quite analogous to the one described above with infested rats, healed by the radiation and showing a parasitic relapse (paragraph 4.3.4).

This phenomenon of therapeutic facilitation can be observed in an absolutely constant fashion in infested rabbits that were healed by a first treatment, each time that the reinfestations (even massive) are accompanied by reduced irradiation to 2 or even only 1 session. We mentioned above that such a reduced treatment is quite

(Page 69)

insufficient to neutralize, by itself, the quantity of inoculated trypanosomes, and that in fact, the necessary treatment in such a case involves a minimum 6 days of treatment, with a daily session of 10 hours.

Yet, in the present case, the one of therapeutic facilitation in rabbits, the animals resist to reinfestations in a perfect manner. The clinical state remains normal and the parasitemia remains negative. The serous level of IgM remains normal or shows a very slight increase; the level of IgG can become higher; these modifications simply attest to the demand on the immune system. This demand translates evidently by an intense deployment of serous antibodies that then exist at high titers.

Seven infested rabbits healed by a first treatment were thus studied with the help of reinfestations (single or multiple) accompanied by a reduced irradiation; we refer to these experiments with the term "Experiments of type AC". We will then describe the results obtained in two of the seven rabbits: rabbits RR13 and RQ86. For the other animals, the results were very similar, with some slight variations (number and rhythm of reinfestations).

./ Case of rabbit RR13 (figure 43 and 44)

.....

It is the case of a rabbit infested with  $5.0E7$  trypanosomes where the treatment (10 sessions of irradiation of 10 hours) was started immediately after the infestation. The evolution of the parasitosis is thus stopped; the parasitemia remains negative; the serous level of IgM remains normal; antibodies (agglutinants and hemagglutinants) appear in relatively moderate quantities.

A first reinfestation with  $2.0E8$  trypanosomes is done 14 days after stopping the treatment; it is accompanied by a single session of irradiation (of 10 hours). The animal resists to this reinfestation: the clinical state remains normal, the negative parasitemia and the level of IgM remains absolutely normal; the titers of humoral antibodies increase considerably (which makes sense: the reinfestation acts in some way as a recall antigenic injection).

(Page 70)

A second reinfestation (also with 2.0E8 trypanosomes also) is done 25 days after the first reinfestation, but this time without a reduced treatment. A severe parasitosis develops right away: the clinical state is affected and a bilateral orchitis develops around the 15th day of the disease; the parasitemia is positive, the serous level of IgM increases rapidly and intensely (up to approximately 16 times the normal rate); the titer of the precipitants antibodies increases also in a considerable manner (and reaches the value 24). The disease ends with death after approximately 3 months of evolution.

./ Case of rabbit RQ86 (figures 45 and 46)

.....

In this animal, the treatment (21 sessions of irradiation of 10 hours each) was started when the trypanosomiasis had been evolving for 24 hours (after an infestation of 5.0E6 trypanosomes) and that the general state had already been reached; the bilateral orchitis began to ulcerate at the scrotum skin; the parasitemia was positive; the immunoglobulins levels (the IgM in particular) were high (titer approximately 8 times the normal level); the titer of the humoral antibodies was also high.

Under the effect of the treatment, the evolution turned rapidly toward healing: the clinical state improves from the first days of the treatment; the testicular lesions (at least the macroscopic lesions) disappear; the parasitemia becomes negative; the serous level of IgM normalizes itself within a 3 weeks period, which is remarkable, the titer of humoral antibodies (hemagglutinants and precipitants) remains approximately at a constant value, with nonetheless a tendency toward a slow decrease (in particular concerning the precipitants antibodies).

We did 2 reinfestations, tardily: the first, on the 295th day and the second on the 315th day after the stop of the first treatment (curative). We accompanied the two reinfestations with a reduced treatment (2 sessions of irradiations of 10 hours each, delayed by one day). The animal resists to the two reinfestations: the general state remains unchanged, the parasitemia remains negative; the level of IgM remains unchanged (normal titer); the titers of the humoral antibodies, still present at the time of reinfestations, raise to considerable values (the reinfestations playing here the role of two recall antigenic injections).

(Page 71)

The study of the two rabbits RR13 and RQ86, as well as the study for the five other rabbits that we do not provide details about here, thus permits the following observations:

- there exists a state of partial immune protection in the rabbits subjected to a first treatment by irradiation (either immediately started after the inoculation of an important infesting dose of trypanosomes, or either healed of a trypanosomiasis evolving for 2 or 3 weeks).
- this state of partial immunity protection can last for a remarkably long period (at least for a year).

- it permits to prove a phenomenon of therapeutic facilitation: the animal resists to important reinfestations of trypanosomes when we accompany them with a reduced treatment (which by itself is incapable of blocking the evolution of the parasites inoculated during the reinfestation).
- finally, the level of humoral antibodies is always high during these reinfestations, which attests there again to the good operation of the immune system.

#### 5.7. - Analysis of the sero-protective power: confirmation of its immunoglobulinic nature

Just as in the mouse healed by the radiation, we researched and repeatedly titered the sero-protective antibodies (see above, paragraph 5.3.3.e). The antibodies are well detectable in the healed rabbits after a first treatment by irradiation, but their titer is generally higher in animals subjected to reinfestations that are accompanied with reduced irradiation.

We wanted to confirm the sero-protective power of the immunoglobulinic substratum; we refer to this experiment with the term “Experiment AD”.

For this, we chose rabbit RR15 that got treated a first time 2 hours after its reinfestation; the treatment lasted 10 days.

(Page 72)

The animal was thus not the center of an evolutive trypanosomiasis. Four reinfestations, each accompanied by a reduced irradiation, were done, two quite precociously (on the 26th and 53rd day after the infestation) and the two others much more tardily (on the 254th and 272nd day after the infestation). The rabbit perfectly resisted to the four reinfestations (figures 47 and 48).

We analyzed 4 serum samples, collected on the following dates:

- before the infestation: sample N
- 18 days after the 1st reinfestation: sample A
- 7 days after the 2nd reinfestation: sample B
- 15 days after the 2nd reinfestation: sample C.

0.4 milliliter of each sample are deposited at the top of 11.6 milliliter of a gradient of saccharose (from 5 to 20%) and subjected to ultracentrifugation at +4 degree Celsius: 24,000 RPM, for 13 hours (centrifuge Beckman-Spinco, model L2-65B, rotor SW-40).

After centrifugation, we take 1 milliliter fractions, in which we simultaneously look for the sero-protective power (by inoculating the fraction to four mice, 0.2 milliliter per animal), the titer of the G and M immunoglobulins (semi-quantitative appreciation using double diffusion) and finally the eventual presence of viral particles. The results of the sero-protective power and of the immunoglobulins dosage are indicated in figure 49 and clearly show that the sero-protective power is linked to immunoglobulins, either to IgG alone (because it exists in the fractions 12 and 11 where this immunoglobulin exists by itself), or either to the IgG and the IgM.



Note that the research on sero-protective power was in fact done in a diluted serous medium. So, if we consider the distribution of the concentrations of the G immunoglobulin, we observe that fraction No. 7 of the sample A (where the sero-protective power is partial) corresponds to serum A diluted approximately 9 times and that fraction No. 8 of the same sample (where the sero-protective power is total) corresponds to serum A diluted approximately 7 times.

(Page 73)

Another observation could be done with this experiment: there exists, but only for samples A, B and C from the fractions collected at the bottom of tubes (fractions No. 2 and especially No. 1) appreciable quantities of IgG. Thus there exists IgG molecules that sediment notably faster than normal IgG molecules; the two IgG zones are even separated by 2 or 3 fractions where the IgG is not detectable.

Such a result strongly evokes the existence of soluble circulating complexes made of trypanosomic antigens molecules linked to IgG antibodies molecules and possessing a high sedimentation constant.

The presence of such antigens-antibodies complexes in the blood circulation, during these prolonged periods, is of utmost interest. Thus, for example, concerning the titers of humoral antibodies, it appears possible that the low titers were due in reality to the fact that an important part of these antibodies are found engaged in complexes, and from then, immunologically neutralized.

This ultracentrifugation experiment and the observation of each fraction under an electronic microscope did not reveal any viral particles, specially in the fractions where a sero-protective power exists.

(Page 74)

## 6. - CHRONIC TRYPANOSOMIASIS OF THE MOUSE WITH T. GAMBIENSE EFFECT OF THE RADIATION

The results that we will describe here are preliminary: the circumstances (breakdowns of the device) did not allow us to do the prolonged treatments that we would have wished.

Nonetheless, we were able to subject mice to treatments of relatively short duration treatment: 4, 6 and 9 days (with a daily session of irradiation of 6 hours). For these three experiments, the mice were infested with  $1.0E3$  parasites and the trypanosomiasis had been evolving for 11 days. At that time, the parasitemia is moderated ( $1.0E1$  to  $1.0E2$  parasites per microliter of blood); the serous level of IgM is already very high (8 to 24 times the normal level, depending on the experiments and the animals).

Here, we will describe the results of the experiment involving 9 days of treatment (experiment AE). On the 11th day of the disease (day on which the treatment starts), the serous level of IgM was already very high: 24 times the normal level (i.e., the level before infestation).

Ten non-treated mice serve as control group. They behave as follows: eight die relatively quickly between the 15th and the 20th day (evolution of type alpha), the two others show a latency phase and die respectively after 2.5 months and 3.5 months (evolution of type beta - see above, paragraph 4.2.2).

Thirty mice were treated; we observe the following phenomena (figures 50 and 51):

- none of the mice evolves toward death within a short period, i.e., not one mouse shows an evolution of parasitosis of type alpha.
- on the contrary, the parasitemia negativates itself after 3 days of treatment.

(Page 75)

- the evolution of the serous level of IgM is particularly interesting. Indeed, this level (which was equal to approximately 24 times the normal level) decreases rapidly in all mice; after approximately 10 days, the level has decreased by half; and after three to four weeks (from the beginning of treatment) the level is almost normalized. Keeping in mind what we know about the catabolism of the IgM and in particular about its half-life (which is 6.3 days in average in the trypanosomed man, Gombert et al. (21)), everything happens as if the massive synthesis of the IgM molecules related to the trypanosomiasis was stopped from the first days of treatment. This phenomenon is interesting.

Afterward, the mice showed two types of evolution:

- In fifteen animals (exactly 50%, we observe an “immunological relapse”: approximately one month after stopping the treatment, the level of IgM increases again, rapidly (within 2 to 3 weeks); and this level will remain high (approximately 24 times the normal level), as a ceiling. In fact, these mice show a trypanosomiasis evolving according to the type beta. The parasitemia is negative. This latency phase lasted between 6 and 18 months, depending on the animals. Finally, trypanosomes appear in the circulating blood, and the mice die within 5 to 10 days (concluding with a massive parasitemia).
- Thirteen mice healed indeed: the parasites remain definitely absent from the circulating blood; the serous level of IgM remains definitely normal.
- Two mice, which also finally healed, first displayed a curious evolution: after its normalization consecutive to the treatment, the serous level of IgM did increase again, but stabilizing to a relatively moderate level (approximately 8 times the normal rate); approximately 6 months afterward, the IgM level finally normalizes itself definitively. The parasitemia always remained negative. It is impossible to determine to what exactly this somewhat intermediary state corresponds to (something between an evolution of trypanosomiasis of type alpha and an immediate healing from the treatment).

(Page 76)

Treatments of lesser duration (from 4 to 6 days) which always started 11 days after the infestation of mice with  $1.0E3$  parasites were done. In these two experiments (experiments AF), each done on a group of thirty mice, the serous level of IgM increased more slowly than for the precedent experiment AE: on the 11th day (day of start of treatment), this level had not yet reached the usual maximal value (approximately 24 times the normal level).

In spite of their short duration, the treatments clearly influence the evolution of the trypanosomiasis:

- the increase of serous level of IgM is slowed.
- the rapid evolution of the disease (of type alpha) is suppressed and all mice display a prolonged disease (of type beta).

These results, as much preliminary as they are, permit us to state nonetheless that:

- the effect of the radiation is certain on the trypanosomiasis of the mouse with *Trypanosoma gambiense*, which has evolved for 11 days.
- treatments of brief duration (of 4 and 6 days) already have a clear influence on the evolution of the parasitosis: the increase in serous level of IgM is slowed and the disease obligatorily evolves into a prolonged mode of type beta.
- a treatment of 9 days brought the healing of 50% of the animals; the remaining 50% showed a disease evolving according to the type beta.

These results appear very encouraging.

(Page 77)

#### 7- PALUDISM OF THE MOUSE WITH P. BERGHEI EFFECT OF RADIATION

We did three experiments (that we refer to with the term of experiments AG) during which thirty mice were infested, each with  $1.0E4$  parasites (elements from the endo-erythrocytic schizogonies), and treated during 10 days (daily sessions of irradiation of 6 hours, the first session starting 2 hours after the infestation); thirty non-treated mice served as control group.

Figure 52 shows the results of one of these experiments. We observe that:

- none of the mice evolves toward healing.
- however, the time of parasitemic latency has increased: the parasitemia becomes detectable only from the 7th day.
- the increase of parasitemia is slightly slowed.

- thus the animals die between the 20th and the 22nd day of the disease (the parasitemia then being of the order of 30%).

We can then say that:

- the effect of the radiation on the paludism of the mouse with Plasmodium Berghei is definite but very partial.
- it appears that the experimental conditions under which we actually operate (in particular the conditions linked to the radiation) are not the optimal conditions for effect on the parasitic model.

It can be hoped that the healing of paludism of mouse with Plasmodium Berghei becomes possible when we will have equipment where the different parameters will be various and freely adjustable.

(Unnumbered page)

### CHAPTER III: DISCUSSION - CONCLUSION

(Page 78)

#### 1- GENERAL CONSIDERATIONS

We were able to point out, in the previous chapter, some biological properties shown by the radiation emitted from our two devices, and more particularly from device No 2.

The effect of this radiation proved to be very strong in the many experimental trypanosomiasis, studied in the framework of this thesis, and much weaker for the experimental paludism of the mouse.

Concerning the many trypanosomiasis, the acute trypanosomiasis of the mouse and rat (with Trypanosoma equiperdum) as well as the chronic trypanosomiasis of rabbit (with Trypanosoma equiperdum) and of the mouse (with Trypanosoma gambiense), the effect of the radiation permits indeed to obtain, under certain conditions of treatment, the healing of the parasitosis, and this even in the case where the treatment by irradiation is started after a certain time of evolution of the disease.

This healing is total and definitive.

From the clinical point of view, the problems of the general state (weight loss, hyperthermy) and the macroscopic lesions regress rapidly and disappear. From the histological point of view, the lesions of the testicular gland, so visible during the chronic trypanosomiasis of the rabbit, also disappear and we observe a regeneration leading to the reestablishment of the normal state. From the biological point of view, the parasites disappear definitively from the circulating blood and also from the miscellaneous organs. The serous levels of the immunoglobulins normalize themselves, in particular the level of IgM, very high during the trypanosomiasis in evolution.

Finally, the healed animal show an excellent immune status, which translates on one hand by a state of resistance, total or partial, to the reinfestations, and on the other hand, by the prolonged deployment of circulating antibodies possessing an agglutinant, hemagglutinant, precipitant and sero-protective power.

(Page 79)

It is likely worthy to repeat that the many experimental trypanosomiasis studied in our thesis - as well as the experimental paludism of the mouse - constitute severe parasitosis evolving every time toward the death of the infested animal.

Concerning the experimental paludism of the mouse with Plasmodium Berghei, we observed a much weaker effect of the radiation. The evolution of the parasitosis is simply slowed, but its outcome remains fatal.

The effect of the radiation transmitted on the experimental trypanosomiasis thus appears as an absolutely original phenomenon. To our knowledge, no biophysical treatment, of whatever nature that it is and applied up to this day, has succeeded to heal these parasitosis. We thus found ourselves under the obligation to examine, with strong rigor, all the experimental conditions concerning our experimentation, which brings us to describe the items hereafter.

#### 1.1. - Control of inoculated trypanosomes - Control animals

For all our experiments, the suspensions of trypanosomes used for the infestation of the animals were subjected, during the quantitative evaluation of parasites (or numeration), to a strict microscopic control; all the trypanosomes must be mobiles.

For all our experiments, we remind you that we always infested, simultaneously and under the same conditions, both the animals destined to be subjected to the irradiation and the control animals to be left without treatment; these control animals always died of their trypanosomiasis, in 100% of the cases.

#### 1.2. - Control Board

A Control Board was formed in 1969 with the aim to attest and verify the effect of the radiation on the acute trypanosomiasis of the mouse. This Commission was presided by Professor Cambar, from the Sciences Faculty of Bordeaux. Ten Faculty Professors and ten non-university personalities signed the final report. The Commission, unanimously, decided to ask for

(Page 80)

the control of all the experiments (preparation of the animals and of the suspension of the trypanosomes, execution of the infestation and of the treatment by irradiation, results) via the custody of a usher. At the end of the experiment, this usher generated an attestation report.

The experiment controlled by the Commission was an experiment of type D. Thirty mice, marked and chosen according to usual statistical techniques (Professor Duhamel) are inoculated with

2.0E4 trypanosomes and treated for 5 days, with a session of irradiation of 6 hours. Thirty mice, marked and chosen under the same conditions, were also infested but non-treated and served as control group.

The results were strictly similar to those described for the experiments of type D. All the treated mice showed first a phase of ascending parasitemia, then a stationary one, and finally all negativated around the 90th hour. The control mice all died of acute trypanosomiasis between the 80th and the 120th hour.

### 1.3. - Eventual existence of a thermal effect

We could assume that the effect of the radiation occurred via the intermediary of a global thermal effect. In other words, the radiation would act by provoking an increase in the body temperature of the irradiated animals.

A priori, an effect of that sort appears highly improbable when we consider the power of the emitted radiation, in particular the power from the UHF wave, where the average energy density is indeed at a maximum of 10 microwatt per square centimeter at the level of the experiment table and at the center of the active zone.

In fact, the experimental results obtained and described in the chapter RESULTS, paragraph 2.8. (Acute trypanosomiasis of the mouse) and 5.4 (chronic trypanosomiasis of the rabbit) confirmed the absence of a global thermal effect.

### 1.4. - The effect of the radiation is not always a total effect

The results obtained show that, under certain experimental circumstances, the effect of the radiation on one hand is not a 100% effect, and that on the other hand, the intensity of its biological effect could

(Page 81)

vary in function of certain factors. Such results constitute both an argument in favor of the rigor of the experimentation and can push us to reflect on the mode of operation of the radiation.

Let us recall briefly these experimental circumstances, which are linked, ones to the properties of the radiation emitted, the others to the conditions of experiment.

#### 1.4.1. - Value of the HF wavelength

For a wavelength equal to 19 meter, we observed that only a part of the infested mice with *Trypanosoma equiperdum* (for example 50% in the experiments of type A) could be negativated. When we reduce the wavelength to 17 meter, with all the other conditions remaining identical, the proportion of negativated animals reaches 100% (experiments of type B).

#### 1.4.2. - Influence of the power of the UHF wave

We showed that the biological effect of the radiation on the acute trypanosomiasis of the mouse varied with the power of the UHF wave.

During the Experiment M which consisted in exposing groups of mice infested with *Trypanosoma equiperdum* to variable powers of UHF waves, we observed that in the mice subjected to a UHF power (average radiated power) ranging from 95 to 700 microwatt, the negativation of the parasitemia occurred in 100% of the cases. Moreover, calculations permitted to show that there exists a relation between the value of the UHF power and the negativation speed of the parasitemia.

However, in mice subjected to a UHF power ranging from 25 to 95 microwatt (these are the ten mice placed in the lodge No 6 during experiment M), the effect of the radiation is not 100% anymore; the negativation of the parasitemia occurs (and with a slight delay) only in eight animals; the two others die of acute trypanosomiasis, just as the mice in cages 1 to 5, which are subjected to a UHF power that is nil.

1.4.3. - The notion of “superior limit of the biological effect of the radiation”.

Concerning the acute trypanosomiasis of the mouse with *Trypanosoma equiperdum*, we saw that the effect of the radiation, started

(Page 82)

two hours after the infestation of the animals, allowed to stop the evolution of the parasitosis in 100% of the animals if the infestation were done with less than or equal to  $2.0E5$  parasites; for superior infestations, only a small proportion of the animals can be negativated in certain cases, but usually the effect of the radiation translates by a simple slowing of the evolution of the parasitosis toward death (experiments of type E).

1.4.4. - Mice infested with *T. Equiperdum* and placed under treatment after 48 hours of evolution of the acute trypanosomiasis

In this type of experiment (experiments of type F), the effect of the radiation succeeds most often to negativate the animals, although the parasitemia, 48 hours after the infestation, is about  $1.0E5$  trypanosomes per microliter of circulating blood. However, during some experiments of this type, some animals (roughly 30%) did not negativate and evolved toward death.

1.4.5. - Duration of treatment by irradiation

The total duration of treatment can, in certain conditions, increase considerably the healing power of the radiation. Thus, for mice infested with *Trypanosoma equiperdum* and subjected 2 hours later to irradiation, a treatment of 5 days permits to heal definitively approximately 30% of the animals, while a treatment of 10 days heals from 90% to 100% (see experiments of types C and I).

1.4.6. - Effect of the treatment by irradiation on the chronic trypanosomiasis of the mouse with *T. Gambiense*

We described an experiment (see experiment AE) where mice, infested eleven days earlier with *Trypanosoma gambiense*, are subjected to a nine day treatment. We showed that, in these conditions, the parasitosis is stopped in all the animals, but that afterward, 50% of the mice display a biological and parasitological relapse with mortal evolution, while the other 50% left remains healed definitively. This is a perfect example of experimental circumstances leading to an effect that is not a 100% effect.

#### 1.4.7. - Effect of the radiation in other parasitic models

We remind you that, for the experimental paludism of the mouse, the effect of the radiation is very partial, which shows the importance of the causal agent at work.

(Page 83)

We can also mention the results obtained in another chronic parasitosis: the mouse infested with *Trypanosoma* (*Schizotrypanum*) *cruzi*. This flagellated protozoan belonging to the subgenus *Schizotrypanum* and not to the *Trypanozoon* subgenus, possesses a biology very different from the one of the *Trypanosoma gambiense* as well as from the *Trypanosoma equiperdum*. In particular, the parasite that exists in the infested organism both under the blood flagellated form (trypomastigote) and under the intra-cellular non-flagellated form (amastigote) multiplies under this latter form.

In this chronic parasitosis of the mouse, the effect of the radiation was nil (12). It is possible that different results will be obtained in the future by varying the experimental conditions, in particular the parameters of the transmitted radiation.

Presently, we believe that we can thus state that our experimentation was done with rigor. The effect of the radiation, on the acute and chronic experimental trypanosomiasis studied in our thesis, thus constitutes a definite, clear and precise effect.

(Page 84)

## 2 - MECHANISM OF OPERATION

We are now able to ask ourselves the question that naturally comes to mind: what is the OR the many mechanisms of operation of the radiation?

Schematically, we could envisage three mechanisms of operation:

- Alpha: either an exclusive effect on the causal agent, the trypanosome.
- Beta: either a stimulation of the defense mechanisms of the parasited organism.
- Gamma: either a combination of the two previous mechanisms.

### 2.1. - Exclusive effect on the trypanosome

The effect on the trypanosome could be a direct or an indirect effect. An example of indirect effect would be the liberation of certain chemical formations such as free radicals, active on certain parasites (Lwoff et al. (36), Dodin et al. (18)).



In our opinion, an exclusive effect on the parasite seems quite unlikely. We will see the reasons why below.

#### 2.1.1. - Propagation of the components of the radiation throughout the organism

We said above that during the acute trypanosomiasis of the mouse and rat and of the chronic trypanosomiasis of the rabbit, the trypanosomes are present, in more or less important quantities, in all the tissues and organs of the infested organism (chapter EQUIPMENT AND METHODS, paragraphs 4.1.1. and 4.2.1.).

Furthermore, we observed that the effect of the radiation on the trypanosomiasis, acute and chronic, required the simultaneous presence of these three essential components: UHF wave, HF wave and magnetic field. Concerning the UHF wave in particular, we were able to

(Page 85)

establish that, if it was not sufficient by itself, its presence seems absolutely primordial and its biological effect would be proportional to its power (Chapter RESULTS, paragraphs 3.2 and 3.3).

However, the penetration and the propagation within the organism are not the same for all three essential components of the radiation.

If the HF wave and the magnetic field penetrate and propagate without much losses in all of the organism, it is not the same for the UHF wave: it loses 50% of its energy during its passage through the skin and it does not penetrate much beyond a depth of 4 to 5 millimeter. In other words, the UHF wave does not propagate in the entire infested mouse, even less for a rat or rabbit.

Yet we observed that the effect of the radiation can lead to the total and definitive parasitological healing of the acute trypanosomiasis of the mouse and rat as well as of the chronic trypanosomiasis of the rabbit.

#### 2.1.2. - The notion of “superior limit of the biological effect of the radiation”

We evoked this notion above, in this chapter, at paragraph 1.4.3. It consists, let us mention it, in the possibility of stopping and even of healing the evolution of an acute trypanosomiasis in a mouse infested with a maximum of  $2.0E5$  trypanosomes.

To us, such a notion appears to be hardly compatible with the hypothesis of an exclusive effect on the parasite.

#### 2.1.3. The phenomenon of therapeutic facilitation

We will discuss this phenomenon a bit further, in particular concerning the rabbit (see same chapter, paragraph 2.2.6).

#### 2.1.4. Irradiation of the trypanosomes maintained alive “in vitro”

We finally mention an experiment during which trypanosomes (*T. Equiperdum*) maintained alive “in vitro” in an appropriate environment (culture of cells KB), were irradiated for 5 days, 6 hours per day, i.e., just like the treated mice during certain of our experiments (experiments of type A, B, C and D). At the end of the experiment, the trypanosomes had remained alive and

(Page 86)

proved to be normally infectious (14).

#### 2.2. - Stimulation of defense mechanisms

The radiation would act by stimulating the defense factors. Some of these factors are of immunological nature: we call them specific. The others are called aspecific.

Within the organism, it is in reality sometimes difficult to separate the two types of factors. Let us take the case of the macrophage cells. During an aggression, infectious or not, these cells are mobilised; they are subject to a series of aspecific but characteristic transformations and they become capable to actively phagocytize micro-organisms or particles. Still, these mobilisation and phagocytosis processes are considerably increased when specific factors intervene, for example, under the form of circulating antibodies bound to the surface of macrophages or to the surface of micro-organisms.

Furthermore, we were able to show during our experimentation that those circulating antibodies could present an important anti-trypanosome power. We were able to detect in the animals (mice, rats and rabbits), infected then treated, sero-protective circulating antibodies (certainly of IgG nature, maybe also of IgM); after reinfestations, the titers of these antibodies are high. It is also more than probable that the agglutinants antibodies (of IgM and IgG nature) play an important role in the battle of the organism for getting rid of the trypanosomes.

Anyway, a series of experimental facts observed in our thesis are compatible with this theory of exaltation of the defense mechanisms. We will review these experimental facts.

##### 2.2.1. - Evolution of the parasitemia in the mice infested with *T. Equiperdum* and treated by irradiation

Let us consider the evolution of the parasitemia during experiments of type D or I, where the mice are infested with  $2.0E4$  trypanosomes and treated for 5 or 10 days, with daily sessions of irradiation of 6 hours, the first session starting 2 hours after the infestation. We saw that during the first 40 to 50 hours, the parasitemia increases noticeably as in the non-treated control mice. Past the 50th hour, the evolution of the parasitemia is very slow

(Page 87)

Compared with the control mice) or even stationary for approximately twenty hours; then comes the negativation, around the 90th hour.

We can admit that starting from the 50th hour after the infestation, and under the influence of the radiation, the defense factors become sufficiently important to provoke the negativation of the parasitemia and the healing.

This effect is absolutely considerable, because around the 50th hour after the infestation, the parasitemia is about  $1.0E5$  parasites per microliter of blood, and the total number of trypanosomes existing in the blood volume alone of a mouse (approximately 2 milliliter) can thus be estimated to approximately  $2.0E8$  trypanosomes.

#### 2.2.2.- Decrease of the parasitemia until the negativation between two seances of irradiation

Concerning the mice thus treated, we said above (see experiment of type C) that we could observe animals that present, at the end of the 4th session of irradiation, a parasitemia that is still relatively high ( $1.0E3$  to  $1.0E4$  trypanosomes per microliter of blood). Although the animals are then withdrawn from the device, the parasitemia continues to decrease and the negativation can occur before the beginning of the 5th session of irradiation, i.e., while still outside of the device. Everything happens as if the defense mechanisms put in place under the influence of the radiation had become sufficient to provoke the negativation.

#### 2.2.3. - Influence of the UHF wave power

We reminded you of the experiment M above (same chapter, paragraph 1.4.2.) and of the behavior of the ten mice in the lodge No 6. For these mice, infested with *Trypanosoma equiperdum* and treated by irradiation, the disease evolves either toward negativation (eight mice out of ten), or either toward a massive parasitemia and the death (two mice out of ten); at the lodge No 6, the UHF power is between 25 and 95 microwatt (average radiated power). It is the same for all the mice within the lodge.

These results can be explained if we admit that the defense mechanisms can reach different levels from one animal to the next;

(Page 88)

it would be these differences of levels that determine whether the disease evolves either toward negativation, or either toward death.

#### 2.2.4. - Effect of the treatment by irradiation on the trypanosomiasis of the mouse with *T. gambiense*

We reminded you above, in the same chapter, at paragraph 1.4.6, of the experiment AE that consisted in treating, by irradiation for 9 days, mice infested for 11 days with *Trypanosoma gambiense*. In this experiment, 50% of the mice showed some relapses with a mortal outcome after a temporary improvement phase, while the remaining 50% evolved toward definitive healing.

We can also believe, here, that the defense mechanisms had reached, under the influence of the radiation, different levels depending on the animals.

### 2.2.5. - Propagation of the components of the radiation in the organism

We talked about this problem above (in this chapter, paragraph 2.1.1.) and the stated considerations are conformed to the hypothesis of an exaltation of the defense mechanisms with the help of the radiation.

### 2.2.6. - Phenomenon of therapeutic facilitation

We were able to show this phenomenon in the rat and the rabbit subjected to a first treatment by irradiation.

#### a. Therapeutic facilitation in the rat

Let us point out that it is about rats infested with *Trypanosoma equiperdum* and treated by irradiation under the usual conditions (daily sessions of 6 hours for 5 days). We saw above (see chapter RESULTS, paragraph 2.7) that after the parasitemic negativation, some animals present a parasitic relapse, the trypanosomes that appear belong to an antigenic type different of the type of base E1 used for the infestation.

We chose rats that were in a relapse phase and showed a parasitemia of about  $1.0E5$  parasites per microliter of blood, which is equivalent to a total number of approximately  $1.0E9$  trypanosomes in their

(Page 89)

blood volume alone. We observed that, in that case, a sole session of irradiation of 6 hours was sufficient to obtain the negativation of the parasitemia and the definitive healing. Yet we know that such a treatment, reduced to one sole session of irradiation, is absolutely incapable to stop the evolution of an acute trypanosomiasis when we inoculate  $1.0E9$  trypanosomes to normal rats.

In short, the reduced treatment seems to act like a recall injection in an organism sensitized to an antigen. The defense factors, specifics and aspecifics, are powerfully amplified during the 2nd treatment (reduced). Furthermore, it appears that these amplified defense factors are active toward trypanosomes that belong to an antigenic type different from the one that originally induced them.

#### b. Therapeutic facilitation in the rabbit

Let us remember that it was shown in rabbits infested with a large number of trypanosomes and put under treatment by irradiation, either very soon (2 hours) after the infestation, or either after 2 to 3 weeks of evolution of the chronic trypanosomiasis.

Applied under the desired conditions (see chapter RESULTS, paragraphs 5.1 and 5.2), this treatment always ends with healing. We said (see chapter RESULTS, paragraph 5.6) that the rabbits healed this way resist to reinfestation done also with a large number of trypanosomes, at the condition however that the reinfestations be accompanied of a

reduced treatment, namely one or two days of treatment, with a daily session of irradiation of 10 hours, the first session starting 2 hours after the reinfestation.

Yet we know that when the trypanosomes are inoculated to normal rabbits, we need a treatment by irradiation that lasts at minimum six days to prevent the evolution of a chronic disease (see chapter RESULTS, paragraph 5.1).

Here also, everything seems to happen as if the second irradiation (reduced) acted like a recall injection.

(Page 90)

Anyway, these phenomena of therapeutic facilitation are definite in the two cases described, in the rat and in the rabbit: the effect of the radiation was greatly helped when the organism was previously subjected to a first treatment by irradiation.

Two experimental facts maybe deserve a particular attention.

#### 2.2.7. - Mice infested with *T. Equiperdum* and treated after 48 hours of evolution of the disease

We could observe, during the experiments of type F, that mice, infested with  $2.0E4$  trypanosomes and placed under treatment only 48 hours later, succeed nonetheless to negativate themselves although each animal is host to a minimum of  $2.0E8$  trypanosomes when the treatment starts. The increase of the parasitemia is already stopped by the 60th hour.

We must then admit an intense stimulation of the defense mechanisms within a very short time: approximately ten hours. Such a stimulation does not appear impossible to us, especially if we consider that it happens in an organism already solicited for approximately 50 hours by the evolution of the trypanosomiasis.

#### 2.2.8. -Effect of the radiation in other parasitic models.

Under the current conditions, the effect of the radiation is very partial in the experimental paludism of the mouse with *Plasmodium Berghei*, and it is nil in the chronic trypanosomiasis of the mouse with *T. (Schizotrypanum) cruzi* (12).

We can then admit that, for various parasitic models studied in our thesis, the defense mechanisms deployed by the parasited organisms are not exactly the same, for example, do not cause the same cellular populations to intervene (macrophage or lymphocytic). The radiation, at least under the actual conditions of operation of our device, would stimulate only some of these defense mechanisms.

(Page 91)

#### 2.3. - Combination of the two previous mechanisms

This hypothesis postulates a synergy between the effect of the radiation per SE and the defense mechanisms. It is then necessary, on one hand, that the parasitic causal agent be “sensitive” to the radiation and that, on the other hand, the specific and aspecific defense mechanisms be put in place within the parasited organism, or both.

The synergy hypothesis accounts quite well, in our opinion, for all the experimental facts observed all along our work.

However, we must remind you that until this day, we could not display any effect of the radiation on the trypanosomes.

(Page 92)

### 3- CONCLUSION

The effect of our radiation on the experimental trypanosomiasis is a definite, clear, and precise effect. It permits the healing of the acute trypanosomiasis of mouse and rat (with *Trypanosoma equiperdum*) as well as the chronic trypanosomiasis of rabbit (with *Trypanosoma equiperdum*) and of the mouse (with *Trypanosoma gambiense*).

It is still too soon to adopt a univocal explanation of the mechanism of operation of the radiation.

However, it is certain that the treatment by irradiation does not decrease the defense mechanisms of the organism, in particular those that are of immunological nature. This fact deserves to be pointed out, because to us, it seems unique up to this day: the ionising radiations usually used in biology attenuate or even suppress the immunity response. It should not be excluded that the radiation, not only does not depress the immune system, but instead exalts the defense mechanisms, and stimulates the synthesis of immunoglobulins and the activation of macrophages.

Anyway, the animals, infested by trypanosomes and then healed by the effect of the radiation, attest to an excellent immune status.

Thus, the mice, infested and healed after a first treatment, show a considerable immunity that practically lasts for all of their life. Thanks to this immunity, the animals can resist to reinfestations made with large doses of parasites and very far in time from the first infestation. Antibodies are present in the blood, more specifically the sero-protective antibodies with strong trypanocide power.

As to the rabbits infested and healed by a first treatment, they develop large quantities of circulating antibodies during many months, among which are the sero-protective antibodies. It is quite

(Page 93)

possible that the antibodies are, at least partially, responsible for the phenomenon that we called therapeutic facilitation: the healed rabbits resist to reinfestations (even done many months after the first treatment) when those are accompanied with a very small irradiation.

In the future, we hope to continue researches concerning the mechanism of operation of our radiation. We plan several experiments among which we can mention the influence of certain immuno-suppressive treatments (X-rays, drugs, anti-lymphocytic immun-serums, thymectomy) and the irradiation of animals before their infestation.

(Unnumbered page)

## RESUME

(Page 94)

The biological effect of the radiation, emitted by the two devices that we built, was studied with the help of parasitic models. The two devices are of the same type: 3 antennas are fitted onto a discharge tube into which is created a plasma that is confined by a longitudinal magnetic field. One transmits a centimetric wave (UHF), and the two others transmit a metric wave (HF).

The parasitic models used are the acute trypanosomiasis of the mouse and rat (*Trypanosoma equiperdum*), the chronic trypanosomiasis of the rabbit (*Trypanosoma equiperdum*), the chronic trypanosomiasis of the mouse (*Trypanosoma gambiense*) and the paludism of the mouse (*Plasmodium Berghei*).

In animals treated by irradiation and in non-treated control animals, we studied on one hand the evolution of the parasitosis (by basing ourselves on clinical signs, certain histological lesions, and the presence or absence of parasites in the peripheral blood), and on the other hand, the immune status (by basing ourselves on three sources: the serous levels of the G and M immunoglobulins, the immune status, and the development of certain circulating antibodies).

Concerning the G and M immunoglobulins, the variations of serous levels of IgM are particularly interesting: the level is very much increased during an evolutive trypanosomiasis and it normalizes itself in case of healing.

The state of immune protection is specific to the antigenic type (or variant) which induced it; its study required the use of cloning techniques that permit to obtain homogenous populations of different antigenic types.

The circulating antibodies studied were the agglutinants antibodies (living trypanosomes), the hemagglutinants antibodies, the precipitants antibodies and the sero-protective antibodies.

(Page 95)

The obtained results can be summarized this way:

A/ Acute trypanosomiasis of the mouse and rat

It evolves toward death within a few days. A single trypanosome is infesting, i.e., can provoke an acute trypanosomiasis. The affection is monitored by evaluating the number of parasites per microliter of circulating blood (parasitemia).

Mice infested with  $2.0E4$  parasites or rats infested with  $2.0E5$  parasites die between the 80th and the 110th hour of the disease.

1) Evolution of the parasitosis under the treatment by irradiation.

Influence of factors linked to the parasitic model

- a) In all the mice infested with  $2.0E4$  trypanosomes, then treated during 5 days at a rate of a daily session of 6 hours, the first session starting 2 hours after the infestation, the parasites disappear from the blood (negativation) around the 90th hour. One third of the mice are definitively healed; the other animals relapse some days after stopping the treatment: trypanosomes appear again in the blood, but they belong to different antigenic types than the antigenic type initially inoculated (which in this case is the type of base E1). After a treatment of 10 days, the healing is obtained in 90% and even 100% of the animals, depending on the experiments.
- b) In mice infested with  $2.0E5$  trypanosomes, the results are very similar. However, for inoculum equal or superior to  $2.0E6$  trypanosomes, the effect of the radiation is incapable of preventing the fatal evolution of the trypanosomiasis.
- c) When we treat mice, not 2 hours after their infestation, but after 24 or even 48 hours, the negativation of the parasitemia and the healing can still be obtained.
- d) Mice with their spleen removed can be healed under the same conditions as the normal mice.

(Page 96)

- e) The normally used strain of *Trypanosoma equiperdum* came from the Pasteur Institute of Paris. However, experiments made with a different strain, said dyskinetoplasmic and coming from Bethesda (USA), gave identical results.
- f) The experimental results obtained are approximately the same in the acute trypanosomiasis of the mouse as in the one of the rat.

2) Immune status of animals treated by the radiation

- a) The mice and the rats, infested then healed by the radiation, display specific circulating anti-trypanosomes antibodies: agglutinants, hemagglutinants, precipitants and sero-protective.
- b) The animals display, in addition, a very strong state of immune protection permitting them to resist reinfestations. This state of protection will last for practically all the life of the mouse. Following reinfestations, the levels of circulating antibodies increase in a very large manner.
- c) In certain rats infested, then negativated by the irradiation treatment and showing afterward a normally mortal parasitic relapse, a single session of irradiation of 6 hours



permitted to these animals to get rid of several trypanosomes (about  $1.0E9$ ), which likely proves some phenomena of “therapeutic facilitation”.

Everything happens as if, in this case, the state of immune protection, induced by the first treatment and theoretically specific of antigenic type of base E1, had greatly helped the effect of the radiation on the evolution of an antigenic type different of the type E1.

### 3) Influence of factors linked to the radiation

- a) During our experimentation, the animals were placed on a plane perpendicular to the axis of the device and distant of 12.5 cm from the output pole of the tube. At a distance of 25 cm, the effect of the radiation on the acute trypanosomiasis of the mouse remains the same.

(Page 97)

- b) If the UHF wave is necessary to the effectiveness of the radiation, it is nonetheless insufficient in itself. In fact, the effect of the radiation on the acute trypanosomiasis requires the simultaneous presence of its 3 major components (UHF wave, HF wave and magnetic field).
- c) The internal voltage of the magnetron must possess a well-defined value otherwise the biological effect decreases in intensity.

## B/ Chronic Trypanosomiasis of the rabbit with *T. Equiperdum*

This is a severe affection constantly leading, after a state of cachexy, to the death of the animal within 5 to 10 weeks. The lesions of the testicles are very important. The changes in the biological state are also important, in particular concerning the M immunoglobulin for which the synthesis has much increased.

### 1) Infested rabbits treated by the radiation

The treatment is done under various conditions:

- a) Treatment started 2 hours after the infestation. It lasts a minimum of 6 days, at the rate of a single daily session of irradiation of 10 hours.

Such a treatment prevents the development of the parasitosis.

- b) Treatment started after a certain time of evolution of the trypanosomiasis. Two or three weeks after infestation, the animals are clinically and biologically very much affected. The treatment, at the condition of applying it for 2 or 3 weeks, at the rate of one daily session of irradiation of 10 hours, can heal the animals definitively, clinically and biologically.

- c) Particularly concerning the severe testicular lesions, the treatment by irradiation leads to the total restoration of the gland, both at the anatomic and functional points of view.

(Page 98)

2) Immune status of rabbits infested then healed by the radiation.

- a) The animals infested, then healed by radiation, develop for many months an important quantity of circulating antibodies: agglutinants, hemagglutinants, precipitants and sero-protective antibodies.
- b) When we perform the reinfestations, the animals do not succeed to get rid of the inoculated trypanosomes. However, they do become capable of doing so when we accompany the reinfestations with a treatment reduced to 1 or 2 sessions of irradiation.

This is another case of “therapeutic facilitation”.

- c) We could confirm, in a rabbit subjected this way to multiple reinfestations accompanied with reduced treatments, the immunoglobulinic nature of the sero-protective power. The concerned antibodies belong with certainty to the IgG class, maybe also to the IgM class.

C/ Chronic trypanosomiasis of the mouse with *T. Gambiense*

This is a disease that can, in certain infested mice, evolve over many months. The biological perturbations are important, in particular concerning the synthesis of M immunoglobulin that is much increased. All the infested animals die of trypanosomiasis.

The effect of the radiation on the disease is certain. We used mice infested 11 days earlier. Treatments of brief duration (from 4 to 6 days, with a daily session of 6 hours) had a definite influence on the evolution of the parasitosis: the increase of the serous level of IgM is slowed and the disease always evolves in a prolonged mode.

A treatment of 9 days was able to bring a definitive healing in 50% of animals; the remaining 50%, after a temporary improvement phase, reflect a disease evolving in a chronic mode.

(Page 99)

D/ Paludism of the mouse with *P. Berghei*

*Plasmodium Berghei* provokes a mortal paludism in the mouse. At the time of death, 30 to 40% of the erythrocytes are parasited. The rapidity of the evolution varies with the number of inoculated parasites.

The mice were infested with 1.0E4 plasmodium. The non-treated control mice die around the 15th day.

The mice treated for 10 days with daily sessions of irradiation of 6 hours, show, compared with the control group, a slowing of the development of the parasitosis and a prolonged survival: they die between the 20th and the 22nd day.

The effect of the radiation on the acute and chronic experimental trypanosomiasis, studied in the framework of this work, is definite, clear and precise: it permits to obtain the definitive healing of these affections that are severe and which, without treatment, are always mortal. On the other hand, in the actual conditions of irradiation on the experimental paludism of the mouse, the effect is only partial.

We believe that it is still too early to adopt a final position concerning its mechanism of operation.

Nonetheless, it appears possible to eliminate, for reasons that are theoretical and experimental, the intervention of a thermal effect, as well as the hypothesis of an effect acting exclusively on the trypanosomes.

We believe, instead, that the radiation acts by stimulating the defense mechanisms, specific and aspecific, in the

(Page 100)

parasited organism. The hypothesis of a synergy between the effect per SE of the radiation on the parasite and the defense mechanisms cannot however be excluded.

Anyway, and this is here a very important fact in our opinion, the immune system of animals treated by the radiation is and remains excellent.

(Unnumbered page)

## BIBLIOGRAPHY

(Page 101)

1- Barnothy J.M.

Development of young mice.

in: Biological effects in magnetic fields, Vol. I, Plenum Press, New York, 1964, p. 93

2 - Barnothy J.M.

Rejection of transplanted tumors in mice.

in: Biological effects in magnetic fields, Vol. I, Plenum Press, New York, 1964, p. 100

3 - Barnothy M.F.

Biological effects in magnetic fields, Vol. I, Plenum Press, New York, 1964

- 4 - Barnothy M.F.  
Haematological changes in mice.  
in: Biological effects in magnetic fields, Vol. I, Plenum Press, New York, 1964, p. 109
- 5 - Barnothy M.F.  
Biological effects in magnetic fields, Vol. II, Plenum Press, New York, 1969
- 6 - Barnwell F.H. and Brown F.A.  
Responses of Planarians and snails.  
in: Biological effects in magnetic fields, Vol. I, Plenum Press, New York, 1964, p. 263
- 7 - Berlureau F.  
Personal communication.
- 8 - Berteaud A.J., Bottreau A.M., Prioré A., Pautrizel A.N., Berlureau F. And Pautrizel R.  
(In French) Attempt of correlation between the evolution of an affection with  
*Trypanosoma equiperdum* and the effect of a pulsed and modulated electromagnetic wave.  
Transactions of the Science Academy (Paris), 1971, Vol. 272, p. 1003  
[Essai de corrélation entre l'évolution d'une affection par *Trypanosoma equiperdum* et  
l'action d'une onde électromagnétique pulsée et modulée.  
Comptes Rendus de l'Académie des Sciences (Paris), 1971, Vol. 272, p. 1003]
- 9 - Bertharion G., Servantie B. And Joly R.  
Electro-cortico-graphic modification after exposure to microwave fields on the white rat  
(preliminary results).  
Journal of Microwave Power, 1971, Vol. 6, p. 62
10. Bertharion G., Servantie B. And Joly R.  
(In French) Study of the effect of an electromagnetic radiation of very high frequency  
(radar) on the central nervous system of the white rat. Electro-cortico-graphic modification.  
Transactions of the Biology Society (Paris), 1971, Vol. 165, p. 1928  
[Etude de l'action d'un rayonnement électromagnétique de très haute fréquence (radar)  
sur le système nerveux central du rat blanc. Modification électro-cortico-graphique.  
Comptes Rendus de la Société de Biologie (Paris), 1971, Vol. 165, p. 1928.]
- 11 - Bray R.S.  
Studies on the exo-erythrocytic cycle in the genus *Plasmodium*.  
1 vol., Lewis edition, London, 1957, p. 192.
- (Page 102)
- 12 - Capbern A.  
Personal communication
- 13 - Carpenter R.L. and Livstone E.M.  
Evidence for non thermal effects of microwave radiation: abnormal development of  
irradiated insect pupae.

IEEE Transactions on Microwave Theory and Techniques, 1971, Vol. 19, p. 173

- 14 - Chateureynaud P.  
Personal communication
- 15 - D'Arsonval A.  
(In French) Effect of a powerful magnetic field on fermentations.  
Transactions of the Biology Society (Paris), 1882, Vol. 34, p. 276  
[Action d'un champ magnétique puissant sur les fermentations.  
Comptes Rendus de la Société de Biologie (Paris), 1882, Vol. 34, p. 276]
- 16 - D'Astre  
(In French) Physiologic influence of the magnetic state.  
Transactions of the Biology Society (Paris), 1882, Vol. 34, p. 278.  
[Influence physiologique de l'état magnétique.  
Comptes Rendus de la Société de Biologie (Paris) , 1882, Vol. 34, p. 278]
- 17 - Delmon C., and Biraben J.  
(In French) Growth of the Guérin's carcinoma under the effect of magnetic fields.  
Comparative Pathology Magazine, 1966, Vol. 3, p. 85  
[La croissance du carcinome de Guérin sous l'action de champs magnétiques.  
Rev. Path. Comp. (Revue de Pathologie Comparée), 1966, Vol. 3, p. 85]
- 18 - Dodin A., and Moreau J.P.  
(In French) Attempt of protection of Man against bilharzian reinfestation by means of inactivated cercaria.  
Transaction of the Science Academy (Paris), 1966, Vol. 263, p. 795  
[Essai de protection de l'Homme contre la réinfestation bilharzienne au moyen de cercaires inactivés.  
Comptes Rendus de l'Académie des Sciences (Paris), 1966, Vol. 263, p. 795]
- 19 - Epstein N. And Cook H.  
The Effects of Microwaves on the Rows N 1 Fowl Sarcoma Virus.  
British Journal of Cancer, 1951, Vol. 5, p. 244
- 20 - Frey A.H.  
Auditory system response to radiofrequency energy.  
Aerospace Medicine, 1961, Vol. 32, p. 1140
- 21 - Gombert J., Bresson G., and Masseyeff R.  
(In French) Abnormal metabolic behavior of macro-immunoglobulin (IgM) of patients afflicted of African trypanosomiasis.  
Transactions of the Science Academy (Paris), 1965, Vol. 261, p. 5729  
[Comportement métabolique anormal de la macro-immunoglobuline (IgM) des malades atteints de trypanosomiase africaine.  
Comptes Rendus de l'Académie des Sciences (Paris), 1965, Vol. 261, p. 5729.]

- 22 - Gordon Z.V.  
Biological effect of microwaves of low intensity.  
Medical Electronic Biological Engineering, 1963, Vol. 1, p. 67
- 23 - Gorodetskaia S.F.  
(Likely not in French nor English) The effect of centimeter waves on the fecundity of female mice.  
Fiziol. Z., 1963, Vol. 9, p. 394
- 24 - Gosset A., Gutmann A., Lakhovsky G., and Magrou J.  
(In French) Attempt of therapeutics of experimental cancer on plants.  
Transactions of the Biology Society (Paris), 1924, Vol. 91, p. 626  
[Essais de thérapeutique du cancer expérimental des plantes.  
Comptes Rendus de la Société de Biologie (Paris), 1924, Vol. 91, p. 626]
- (Page 103)
- 25 - Gross L., and Smith L.W.  
Wound Healing and Tissue Regeneration.  
in: Biological Effects of Magnetic Fields, Vol. I, Plenum Press, New York, 1964, p. 140
- 26 - Imic C.J., Thompson J.D., and Hines H.M.  
Testicular Degeneration as a Result of Microwave Radiation.  
Electrical Energy, 1952, Vol. 71, 979
- 27 - Joly R  
(In French) Biological effects and eventual danger of V.H.F. radiations of airborne radars.  
Archives of Professional Diseases, 1968, Vol. 29, p. 121  
[Effets biologiques et danger éventuel des rayonnements T.H.F. des “aériens-radars”.  
Arch. Mal. Prof. (Archives des Maladies Professionnelles), 1968, Vol. 29, p. 121]
- 28 - Joly R., Plurien G., Douet J., and Servantie B.  
(In French) Eventual biological and physiopathological effects of the UHF electromagnetic radiations of airborne radars.  
Magazine Body Health Armies, 1969, Vol. 10, p. 239  
[Effets biologiques et physiopathologiques éventuels des rayonnements électromagnétiques UHF des “aériens-radars”.  
Revue Corps Santé Armées, 1969, Vol. 10, p. 239]
- 29 - Klein F., Mattern P., and Kornman van der Bosch H.J.  
Experimental induction of rheumatoid factor-like substances.  
Clin. Exp. Immunol. (Clinical & Experimental Immunology), 1970, Vol. 7, p. 851
- 30 - Lakhovsky G.  
(In French) The Origin of Life. Radiation and the living beings.  
1 vol., Gauthier Villars edition, Paris, 1925  
[L'origine de la vie. La radiation et les êtres vivants.]

1 vol., Gauthier Villars édition, Paris, 1925]

- 31 - Lanham S.M. and Godfrey D.G.  
Isolation of Salivarian Trypanosomes from Man and other mammals using DEAE-cellulose.  
Expl. Parasit. (Experimental Parasitology), 1970, Vol. 28, 521
- 32 - Laveran A., and Mesnil F.  
(In French) On the agglutination of trypanosomes of rat by miscellaneous serums.  
Transactions of the Biology Society (Paris), 1900, Vol. 52, p. 939  
[Sur l'agglutination des trypanosomes du rat par divers sérums.  
Comptes Rendus de la Société de Biologie (Paris), 1900, Vol. 52, p. 939]
- 33 - Laveran A., and Mesnil F.  
(In French) Trypanosomes and Trypanosomiasis.  
1 vol., Masson Edition, Paris, 1912  
[Trypanosomes et Trypanosomiase.  
1 vol., Masson Edition, Paris, 1912]
- 34 - Lazarovitch V.G.  
(Likely not in French nor English) Influence of UHF magnetic fields on the concentration of iron, copper and some metalloproteins of blood and tissues.  
Bjull. Eksper. Biol. Med., 1970, Vol. 35, p. 44  
[Influence des champs magnétiques UHF sur la teneur en fer, cuivre et quelques métalloprotéines du sang et des tissus.  
Bjull. Eksper. Biol. Med., 1970, Vol. 35, p. 44]
- 35 - Lobanova E.A.  
The survival and development of animals exposed to SHF fields on different intensity and duration.  
In: The Biological Action of Superhigh Frequencies, Moscow, 1960, p. 61.
- 36 - Lwoff A., and Morel M.  
(In French) The effect of vitamin C on the multiplication of *Proteus vulgaris*.  
Annals of Pasteur Institute, 1942, Vol. 68, p. 255.  
[L'action de la vitamine C sur la multiplication de *Proteus vulgaris*.  
Annales de l'Institut Pasteur, 1942, Vol. 68, p. 255]
- (Page 104)
- 37 - Lysina G.G.  
(Likely not in French nor English) Blood changes caused by the VHF.  
Gig. I. Sanit. Kiev, 1965, Vol. 6, p. 95
- 38 - McAfee R.M.  
Physiological effects of thermode and microwave stimulation of peripheral nerves.  
American Journal of Physiology, 1962, Vol. 203, p. 374

- 39 - McNeillage G.J.C., Herbert W.J. and Lumsden W.H.R.  
Antigenic type of first relapse variants arising from a strain of *Trypanosoma brucei*.  
Expl. Parasit. (Experimental Parasitology), 1969, Vol. 25, p. 1
- 40 - Mancini G., Carbonara A.O. and Heremans J.F.  
Immunochemical quantitation of antigens by single radial immunodiffusion.  
Immunochemistry, 1965, Vol. 2, p. 235
- 41 - Mattern P.  
(In French) Actual state and results of immunological techniques used at the Pasteur Institute of Dakar for the diagnostic and the study of the human African trypanosomiasis.  
Bulletin World Health Organization, 1968, Vol. 38, p. 1  
[Etat actuel et résultats des techniques immunologiques utilisées à l'Institut Pasteur de Dakar pour le diagnostic et l'étude de la trypanosomiase humaine africaine.  
Bulletin de l'Organisation Mondiale de la Santé, 1968, Vol. 38, p. 1]
- 42 - Mattern P., Bentz M., and MacGregor I.A.  
(In French) The precipitants antibodies present in blood and in cephalo-rachidian fluid of patients afflicted with human African trypanosomiasis, with T. Gambiense.  
Annals of Pasteur Institute, 1967, Vol. 112, p. 105  
[Les anticorps précipitants présents dans le sang et dans le liquide céphalo-rachidien de malades atteints de trypanosomiase humaine africaine, à T. Gambiense.  
Annales de l'Institut Pasteur, 1967, Vol. 112, p. 105]
- 43 - Mattern P., Duret J., and Pautrizel R.  
(In French) Hyper-Beta 2- macroglobulinemia during experimental trypanosomiasis of rabbit with *Trypanosoma equiperdum*.  
Transactions of the Science Academy (Paris), 1963, Vol. 256, p. 820  
[Hyper-Beta 2-macroglobulinémie au cours de la trypanosomiase expérimentale du lapin à *Trypanosoma equiperdum*.  
Comptes Rendus de l'Académie des Sciences (Paris), 1963, Vol. 256, p. 280]
- 44 - Mattern P., Mayer G., and Fellici M  
(In French) Existence of amastigotic forms of *Trypanosoma gambiense* in the plexual choroidian tissue of the mouse experimentally infected.  
Transactions of the Science Academy (Paris) 1972, Vol. 274, p. 1513  
[Existence de formes amastigotes de *Trypanosoma gambiense* dans le tissu plexuel choroïdien de la souris infectée expérimentalement.  
Comptes Rendus de l'Académie des Sciences (Paris), 1972, Vol. 274, p. 1513.]
- 45 - Mayer G., Prioré A., Mayer G., and Pautrizel R.  
(In French) Effect of magnetic fields associated to electromagnetic waves on the trypanosomian orchitis of rabbit.  
Transactions of the Science Academy (Paris), 1972, Vol. 274, p. 3011  
[Action de champs magnétiques associés à des ondes électromagnétiques sur l'orchite trypanosomienne du lapin.  
Comptes Rendus de l'Académie des Sciences (Paris), 1972, Vol. 274, p. 3011]



- 46 - Michaelson S.M.  
Human exposure to non-ionizing radiant energy-potential hazards and safety standards.  
Proceedings of the IEEE, 1972, Vol. 60, p. 389
- 47 - Miro L.  
(In French) Note on the radioprotection exerted by ultra-short waves (UHF) against bacteria.  
Magazine of Aerospace Medicine???, 1965, Vol. 4, p. 21.  
[Note sur la radioprotection exercée par les ondes ultra-courtes vis-à-vis des bactéries.  
Rev. Med. Aero. (Revue de Médecine Aéronautique???), 1965, Vol. 4, p. 21.]
- (Page 105)
- 48 - Miro L., Deltour G., Pfister A., Donadieu L., and Royet J.  
(In French) Influence of the variations of a magnetic field on the growth of certain micro-organisms.  
Journal of Physiology, 1967, Vol. 59, p. 267.  
[Influence des variations d'un champ magnétique sur la croissance de certains micro-organismes. Journal de Physiologie, 1967, Vol. 59, p. 267]
- 49 - Miro L., Loubiere R., and Pfister A.  
(In French) Morphologic and metabolic changes observed experimentally under the effect of microwave electromagnetic fields.  
Magazine Aerospace medicine???, 1966, Vol. 5, p. 9  
[Modifications morphologiques et métaboliques observées expérimentalement sous l'action des champs électromagnétiques hyperfréquence.  
Rev. Med. Aero. (Revue Médecine Aéronautique???), 1966, Vol. 5, p. 9]
- 50 - Pautrizel R.  
Personal communication
- 51 - Pautrizel R., Duret J., Tribouley J., and Ripert Ch.  
(In French) Study of the specificity of the agglutination reaction of trypanosomes during trypanosomoses.  
Bulletin of the Exotic Pathology Society, 1962, Vol. 55, p. 383  
[Etudes de la spécificité de la réaction d'agglutination des trypanosomes au cours des trypanosomoses.  
Bull. Soc. Path. Exot. (Bulletin de la Société de Pathologie Exotique), 1962, Vol. 55, p. 383]
- 52 - Pautrizel R., Duret J., Tribouley J., and Ripert Ch/  
(In French) Comparative study of the evolution of different antibodies deployed during experimental trypanosomoses in the rabbit.  
Magazine Immunology, 1962, Vol. 26, p. 157  
[Etude comparative de l'évolution de différents anticorps élaborés au cours de trypanosomoses expérimentales chez le lapin.  
Revue Immunologie, 1962, Vol. 26. P. 157]

- 53 - Pautrizel R., Mattern P., Prioré A., Pautrizel A.N. and Bernard D.  
(In French) State of protection toward *Trypanosoma equiperdum* in mice splenectomized and subjected to a physical stimulation.  
First European multi-symposium of parasitologie - Rennes (France) - 1 to 4 September 1971, p. 116.  
[Etat de protection vis-à-vis de *Trypanosoma equiperdum* chez des souris splénectomisées et soumises à une stimulation physique.  
Premier Multi-Colloque européen de parasitologie - Rennes - 1 au 4 Septembre 1971, p. 116.]
- 54 - Pautrizel R., Prioré A., Berlureau F., and Pautrizel A.N.  
(In French) Stimulation, via physical means, of the defenses of the mouse and rat against the experimental trypanosomiasis.  
Transactions of the Science Academy (Paris), 1969, Vol. 268, p. 1889.  
[Stimulation, par des moyens physiques, des défenses de la souris et du rat contre la trypanosomose expérimentale.  
Comptes Rendus de l'Académie des Sciences (Paris), 1970, Vol. 268, p. 1889]
- 55 - Pautrizel R., Prioré A., Berlureau F., and Pautrizel A.N.  
(In French) Effect of magnetic fields combined to electromagnetic waves on the experimental trypanosomoses of the rabbit.  
Transactions of the Science Academy (Paris), 1970, Vol. 271, p. 877  
[Action de champs magnétiques combinés à des ondes électromagnétiques sur la trypanosomose expérimentale du lapin.  
Comptes Rendus de l'Académie des Sciences (Paris), 1970, Vol. 271, p. 877.]
56. Pautrizel R., Prioré A., Dallochio M., and Crockett R.  
(In French) Effect of electromagnetic waves and of magnetic fields on the lipidic changes caused in the rabbit by the administration of a hypercholesterol food diet.  
Transactions of the Science Academy (Paris), 1972, Vol. 274, p. 488  
[Action d'ondes électromagnétiques et de champs magnétiques sur les modifications lipidiques provoquées chez le lapin par l'administration d'un régime alimentaire hypercholestérolé.  
Comptes Rendus de l'Académie des Sciences (Paris), 1972, Vol. 274, p. 488]
- 57 - Pautrizel R., Rivière M., Prioré A., and Berlureau F.  
(In French) Influence of electromagnetic waves and of associated magnetic fields on the immunity of the mouse infested with *trypanosoma equiperdum*.  
Transactions of the Science Academy (Paris), 1966, Vol. 263, p. 579.  
[Influence d'ondes électromagnétiques et de champs magnétiques associés sur l'immunité de la souris infestée par *Trypanosoma equiperdum*.  
Comptes Rendus de l'Académie des Sciences (Paris), 1966, Vol. 263, p. 579.]

(Page 106)

58 - Pazderova J.

(Likely not in English nor French) Effects of electromagnetic radiation of the order of centimeter and meter waves on humans's health.

Pracovni Lek., 1968, Vol. 20, p. 447

59 - Percovskij A.I., Irocenko J.Ia., Guz S.Ia., Volkov E.S., Barko A.I. and Koshljak T.N.

(Likely not in English nor French) The influence of a high frequency electromagnetic field through the evolution of experimental atherosclerosis.

Patol. Fiziol. Terap., 1969, Vol. 13, p. 64.

60 - Petrov F.P., and Soubotta A.G.

(Likely not in English nor French) Effect of UHF electromagnetic waves on the organism.

Vo.-med. Z., 1966, Vol. 2, p. 16

61 - Plurien G., Sentenac-Roumanov H., Joly R., and Drouet J.

(In French) Influence of the electromagnetic radiation from a radar transmitter on the phagocytic function of the reticulo-endothelial system.

Transactions of the Biology Society (Paris), 1966, Vol. 160, p. 597

[Influence du rayonnement électromagnétique d'un émetteur radar sur la fonction phagocytaire du système réticulo-endothélial.

Comptes Rendus de la Société de Biologie (Paris), 1966, Vol. 160, p. 597]

62 - Presman A.S.

Electromagnetic fields and life.

1 vol., Plenum Press, New York and London, 1970

63 - Presman A.S., and Levitina N.A.

(Likely not in English) The non-thermal effect of microwaves on the systolic rhythm of animals.

Bjull. Eksper. Biol. Med., 1962, Vol. 53, p. 39

64 - Presman A.S., and Levitina N.A.

(Likely not in English) Influence of the irradiation by non-thermal microwaves on the resistance of animals to gamma irradiation.

Radiobiologija, 1962, Vol. 2, p. 170

65 - De Raadt P.

(In French) Taxonomy of trypanosomes, parasites of mammals.

World Health Organization. Document WHO/TRYP/73.39.

[Taxonomie des trypanosomes, parasites des Mammifères.

Organisation Mondiale de la Santé - Document: WHO/TRYP/73.39.

- 66 - Reno V., and Nutini N.G.  
Tissues respiration.  
in: Biological effects of magnetic fields,  
Vol. I, Plenum Press, New York, 1964, p. 211
- 67 - Rivière M.R., and Guérin M.  
(In French) New research done in rats carrier of a lymphoblastic lymphosarcome subjected to the effect of electromagnetic waves associated to magnetic fields.  
Transactions of the Science Academy (Paris), 1966, Vol. 262, p. 2669.  
[Nouvelles recherches effectuées chez des rats porteurs d'un lymphosarcome lymphoblastique soumis à l'action d'ondes électromagnétiques associées à des champs magnétiques.  
Comptes Rendus de l'Académie des Sciences (Paris), 1966, Vol. 262, p. 2669.]
- 68 - Rivière M.R., Prioré A., Berlureau F., Fournier M and Guérin M.  
(In French) Effect of electromagnetic fields on grafts of the T-8 tumor in the rat.  
Transactions of the Science Academy (Paris), 1964, Vol. 259, p. 4895.  
[Action de champs électromagnétiques sur les greffes de la tumeur T 8 chez le rat.  
Comptes Rendus de l'Académie des Science (Paris), 1964, Vol. 259, p. 4895.]
- (Page 107)
- 69 - Rivière M.R., Prioré A., Berlureau F., Fournier M and Guérin M.  
(In French) Effects of electromagnetic fields on a graftable lymphoblastic lymphosarcome of the rat.  
Transactions of the Science Academy (Paris), 1965, Vol. 260, p. 2099.  
[Effets de champs électromagnétiques sur un lymphosarcome lymphoblastique transplantable du rat.  
Comptes Rendus de l'Académie des Sciences (Paris), 1965, Vol. 260, p. 2099.]
- 70 - Rivière M.R., Prioré A., Berlureau F., Fournier M and Guérin M.  
(In French) Phenomena of regression observed on grafts of a lymphosarcome in mice exposed to electromagnetic fields.  
Transactions of the Science Academy (Paris), 1965, Vol. 260, p. 2639.  
[Phénomènes de régression observés sur les greffes d'un lymphosarcome chez des souris exposées à des champs électromagnétiques.  
Comptes Rendus de l'Académie des Sciences (Paris), 1965, Vol. 260, p. 2639.]
- 71 - Rhodain J.  
(In French) The pre-erythrocytic forms of Plasmodium vivax in the chimpanzee.  
Annals of the Belgian Society of Tropical Medicine, 1956, Vol. 36, p. 99  
[Les formes pré-érythrocytaires du Plasmodium vivax chez le chimpanzé.  
Ann. Soc. Belge Med. Trop. (Annales de la Société Belge de Médecine tropicale), 1956, Vol. 36, p. 99]

- 72 - Rocard Y.  
Actions of a very weak magnetic gradient. The reflex of the Dowser.  
In: Biological effects of magnetic fields.  
Vol. I, Plenum Press, New York, 1964, p. 279.
- 73 - Schwan H., and Li K.  
Variations between measured and biologically effective microwave diathermy dosage.  
Arch. Phys. Med. Rehab (Archives of Physical Medicine & Rehabilitation), 1955, Vol. 36,  
p. 363.
- 74 - Schwan H., and Piersol G.M.  
The absorption of electromagnetic energy in body tissues (Review and critical analysis).  
Am. J. Phys. Med. (American Journal of Physical Medicine), 1954, Vol. 33, p. 371
- 75 - Schwan H., and Sher L.D.  
Alternating-current field-induced forces and their biological implications.  
J. Electrochem. Soc. (Journal of the Electrochemistry Society), 1969, Vol. 116, p. 220.
- 76 - Servantie B.  
(Likely not in French nor English) Attempt of synthesis regarding biological effects of  
microwaves.  
Electron. Fisc. Apli., 1973, Vol. 16, p. 545
- 77 - Servantie B., Bertharion G., and Joly R.  
(In French) Influence of an electromagnetic radiation of very high frequency on the  
sensitivity of pentetrazol in the white mouse.  
Transactions of the Biology Society (Paris), 1971, Vol. 165, p. 1952.  
[Influence d'un rayonnement électromagnétique de très haute fréquence sur la sensibilité  
de pentetrazol chez la souris blanche.  
Comptes Rendus de la Société de Biologie (Paris), 1971, Vol. 165, p. 1952]
- 78 - Servantie B., Bertharion G., and Joly R.  
(In French) Influence of an electromagnetic radiation of very high frequency on the  
sensitivity to gallamine triiodoethylate and to suxamethonium iodide in the white rat.  
Transactions of the Biology Society (Paris), 1971, Vol. 165, p. 376.  
[Influence d'un rayonnement électromagnétique de très haute fréquence sur la sensibilité  
au triiodoethylate de gallamine et à l'iodure de suxamethonium chez Le rat blanc.  
Comptes Rendus de la Société de Biologie (Paris), 1971, Vol. 165, p. 376.]
- 79 - Servantie B., and Joly R.  
(In French) Radar - Biological research and medicine at work.  
Gaz. Hospital (Paris), 1970, Vol. 31, p. 797.  
[Radar - Recherche biologique et médecine du travail.  
Gaz. Hôpital (Paris), Vol. 31, p. 797]

(Page 108)

- 80 - Servantie B., Joly R., and Bertharion G.  
Experimental study of the biological effects of microwave radiation of the white rat and mouse.  
Journal of Microwave Power, 1971, Vol. 6, p. 59.
- 81 - Shortt H.E. and Garnham P.C.C.  
The pre-erythrocytic development of Plasmodium cynomolgi and Plasmodium vivax.  
Transaction of the Royal Society of Tropical Medicine and Hygiene, 1948, Vol. 41, p. 785.
- 82 - Teixeira-Pinto A.A., Nejelski L.L., Cutler J.L., and Heller J.H.  
The behavior of unicellular organisms in an electromagnetic field.  
Experimental Cellular Research, 1960, Vol. 20, p. 548.
- 83 - Thomson R.A.E. and Michaelson S.M.  
Leukocyte response following simultaneous ionizing and microwave (radar) irradiation.  
Blood, 1966, Vol. 28, p. 157.
- 84 - Tribouley-Duret J.  
(In French) Experimental research on the antigenicity of trypanosomes.  
State thesis in pharmacy, Bordeaux, 1961.  
[Recherches expérimentales sur l'antigénicité des trypanosomes.  
Thèse d'Etat en pharmacie, Bordeaux, 1961]
- 85 - Tribouley J., Tribouley-Duret J., Iribarren M.J., and Pautrizel R.  
(In French) Evidence of specific antibodies of fasciola hepatica by passive hemagglutination using glutaraldehyde as coupling agent.  
Transactions of Science Academy (Paris), 1969, Vol. 268, p. 2215.  
[Mise en évidence des anticorps spécifiques de fasciola hepatica par hémagglutination passive en utilisant la glutaraldéhyde comme agent de couplage.  
Comptes Rendus de l'Académie des Sciences (Paris), 1969, Vol. 268, p. 2215.]
- 86 - Tyagin N.V.  
(Likely not in English) Changes in the blood of animals due to a SHF field.  
Trud. Vo.-med. Akad. (Leningrad), 1957, Vol. 73, p. 116.
- 87 - Webb S.J. and Booth A.D.  
Absorption of microwave by microorganisms.  
Nature (London), 1969, Vol. 222, p. 1199.
- 88 - Zaret M.M.  
The biological effects of microwave radiation.  
Industrial Hygiene Review., 1962, Vol. 5, p. 11.

## FIGURES

Fig 1 - Photo of device No 1.

Fig 2 - Photo of device No 2.

Fig 3 - High level (synoptic) Diagram of the devices.

Emetteur HF: HF transmitter  
Emetteur UHF: UHF transmitter  
Anode tournante: rotating anode  
Bobine magnétisante: magnetic coil  
Cathode: cathode  
Plaques défectrices: Deflecting plates

Fig 4 - UHF electromagnetic wave. Distribution of the field power in a plane perpendicular to the axis of the device and at a distance of 5 cm from the output face of the plasma tube. Device No 2.

Tube = tube  
O with / in it: means diameter (of 24 cm)

Fig 5 - Magnetic field. Evolution of a pulse. Device No 2.

Temps: Time

Fig 6 - Magnetic field. Spatial distribution of the magnetic field along the axis of the plasma tube. d=distance relative to the output face of the tube. Device No 2.

Fig 7 - Magnetic field. Spatial distribution in a plane perpendicular to the axis of the device and at a distance of 4.2 cm from the output face of the plasma tube. Device No 2.

Tube: tube  
O with / in it: means diameter (of 24 cm)

Table 1 - Position of *T. Equiperdum* and of *T. Gambiense* in the classification proposed in 1973 by the World Health Organization (65)

Phylum: phylum  
Classe: class  
Ordre: order  
Famille: Family  
Genre: genus  
Sous-genre: subgenus  
Espèce: species  
Sous-espèce: subspecies

Fig 8 - Acute trypanosomiasis of the mouse with *T. Equiperdum*. Semi-quantitative evaluation of the parasitemia on blood smears, colored by the May-Grünwald-Giemsa technique.

- a:+ corresponds to approximately less than/equal to  $1.0E3$  trypanosomes per microliter of blood
- b:++ corresponds to approximately  $1.0E4$  trypanosomes per microliter of blood
- c:+++ corresponds to approximately  $1.0E5$  trypanosomes per microliter of blood
- d:++++ corresponds to approximately larger than/equal to  $1.0E6$  trypanosomes per microliter of blood

Fig 9 - Paludism of the mouse (*P. berghei*). Semi-quantitative evaluation of the parasitemia: the proportion of the parasited red blood cells is expressed in %. Blood smears, colored by the May-Grünwald-Giemsa technique.

- a: approximately 5% of the red blood cells are parasited
- b: approximately 40% of the red blood cells are parasited

Fig 10 - Acute trypanosomiasis of the mouse (*T. Equiperdum*). Relation between the number of inoculated trypanosomes (antigenic type of base E1) and the survival time of the animals. Each dose of trypanosomes ( $1.0E0$ , E1, E2, ....E8) was inoculated to 6 mice.

Nombre de trypanosomes inoculés: Number of trypanosomes inoculated.  
Heures: hours

Fig 11 - Acute trypanosomiasis of the mouse (*T. Equiperdum*). Evolution of the parasitemia (number of trypanosomes per microliter of blood) in a lot of 30 mice each infested with  $2.0E4$  trypanosomes. Between parenthesis is the number of mice alive at the time of the numeration of the trypanosomes.

Trypanosomes par ul: trypanosomes per microliter  
Jours: days

Fig 12 - Trypanosomiasis of the mouse (*T. Equiperdum*). Diagram of the antigenic variation in the case of a mouse infested with a reduced number of trypanosomes belonging to an antigenic type different of the type of base E1. The variation always occurs toward this last type.

Trypanosomes par ul: trypanosomes per microliter  
Heures: hours

Fig 13 - Chronic trypanosomiasis of the rabbit (*T. Equiperdum*). Clinical aspect of an animal infested since 3 weeks.

Fig 14 - Same rabbit as on previous figure. Clinical aspect of muzzle, ears and of the ocular mucous membrane.

Fig 15 - Chronic trypanosomiasis of the rabbit with *T. Equiperdum*. Clinical aspect of the testicular affection in a rabbit infested since 3 weeks.

Fig 16 - Histological aspects of the testicular gland in a normal rabbit.



- a: seminal tubes (magnifying power 10 x 3.2)
- b: seminal tubes (magnifying power 40 x 3.2)
- c: epididymal tubes (magnifying power 4 x 3.2)
- d: epididymal tubes (magnifying power 25 x 3.2)

Fig 17 - Chronic trypanosomiasis of the rabbit (*T. Equiperdum*). Histological aspect of the testicular gland in a rabbit infested since 8 days.

- a: seminal tubes (magnifying power 10 x 3.2)
- b: seminal tubes (magnifying power 40 x 3.2)
- c: epididymal tubes (magnifying power 4 x 3.2)
- d: epididymal tubes (magnifying power 25 x 3.2)

Fig 18 - Chronic trypanosomiasis of the rabbit (*T. Equiperdum*). Histological aspect of the testicular gland in a rabbit infested since 15 days.

- a: seminal tubes (magnifying power 10 x 3.2)
- b: seminal tubes (magnifying power 40 x 3.2)
- c: epididymal tubes (magnifying power 4 x 3.2)
- d: epididymal tubes (magnifying power 25 x 3.2)

Fig 19 - Chronic trypanosomiasis of the rabbit (*T. Equiperdum*). Histological aspect of the testicular gland in a rabbit infested since 30 days.

- a: seminal tubes (magnifying power 10 x 3.2)
- b: seminal tubes (magnifying power 40 x 3.2)
- c: epididymal tubes (magnifying power 4 x 3.2)
- d: epididymal tubes (magnifying power 25 x 3.2)

Fig 20 - Chronic trypanosomiasis of rabbit (*T. Equiperdum*). Diagram of the antigenic variation. The evolution of the successive antigenic types induces the deployment, by the infested animal, of antibodies of which certain are specific of these antigenic types (it is the case of agglutinants antibodies and of certain precipitants antibodies.)

Jours = days  
 anticorps anti-E1 = Anti-E1 antibodies  
 anticorps anti-E2 = Anti-E2 antibodies  
 etc

Fig 21 - Chronic trypanosomiasis of the mouse (*T. Gambiense*).  
 Diagram of the evolution of the parasitosis in mice infested with 1.0E3 trypanosomes (strain D2/1).  
 Evolution of the parasitemia (number of trypanosomes per microliter of blood) and of the serous level of IgM (expressed in multiples of the level existing before the experiment). Are also indicated, the 2 possible modalities (alpha and beta) of the evolution of the parasitosis in the mouse.

Trypanosomes par ul = trypanosomes per microliter

Fig 22 - Chronic trypanosomiasis of the rabbit (*T. Equiperdum*).

Rabbit RR14 - infested with  $2.0E7$  trypanosomes.

Indication of the parasitemia. Evolution of the ratio albumin/globulins and of serous levels of immunoglobulins G (IgG) and M (IgM). The levels of immunoglobulins are expressed in multiples of the levels existing before the infestation. The animal dies 112 days after the infestation.

Black triangle: infestation

+ presence of trypanosomes in blood

Jours = days

Fig 23 - Immunoglobulin M - Principle of evaluation of its serous level. Semi-quantitative technique, by double diffusion in a gel of gelose. The central hole receives the monospecific anti-IgM immun-serum (7 microliter). The peripheric holes receive 7 microliter of the analysed serum or of its dilutions (in geometric progression of factor 2; the pure serum is located on the right of the central hole; the dilutions go clockwise).

Case of dosage of IgM in a trypanosomed rabbit (*T. equiperdum*).

a: before the infestation

b: three weeks after the infestation: the level has increased by approximately 6 times relative to the precedent level.

Table II - Diagram of some properties of the immune systems studied (trypanosomiasis caused by *Trypanosoma equiperdum*).

First row, first column: immune system

First row, 2nd column: Antigens are: Specifics of antigenic type

First row, 3rd column: Antigens are: Common to all antigenic types

First row, 4th column: Antibodies are of nature: IgM

First row, the column: Antibodies are of nature: IgG

“et” means “and”

Fig 24 - Anti-trypanosomes precipitants antibodies. Evidence in mice afflicted of chronic trypanosomiasis (*T. Gambiense* - strain D2/1) displayed by a technique of double diffusion in gel of gelose.

The central hole receives 7 microliter of antigenic reagent (see the text). The peripheric holes receive the serums from 6 mice. The serums of mice A, B, C and D contain precipitants antibodies. The serums of mice E and F do not contain any. We note a reaction of total non-identity between the line of precipitation corresponding to serum A on one hand and the lines of precipitation corresponding to serums B, C and D on the other hand.

Fig 25 - Anti-trypanosomes precipitants antibodies. Evidence by immuno-electrophoretic analysis in a trypanosomed rabbit (T. Equiperdum). The antigenic reagent (see the text of the experimental details) is subjected to electrophoretic migration.

Upper gutter: serum collected 2 weeks after infestation

Lower gutter: serum collected 5 weeks after infestation

We note a major precipitation arc in the cathodic zone. This arc has a tendency to weaken during the evolution of the affection. It is due to the exo-antigen of antigenic type of base E1 reacting with the corresponding antibodies.

Fig 26 - Chronic trypanosomiasis of rabbit (T. Equiperdum)

Rabbit RR14. Infested with  $2.0E7$  trypanosomes.

Evolution of precipitants antibodies (Ac. Précip.), agglutinants antibodies (Ac. Aggl.) and hemagglutinants antibodies (Ac. Hémaggl.). Their level is expressed by the inverse of the dilution giving a positive reaction. The animal dies 112 days after the infestation.

Black triangle: infestation

+ presence of trypanosomes in the blood

jours = days

Fig 27 - Treatment by irradiation of the acute trypanosomiasis of the mouse (T. Equiperdum)

Evolution of the parasitemia (number of trypanosomes per microliter of blood) during an experiment of type A (device No 1- HF wavelength: 19 meter - daily irradiations of 12 hours during 5 days) in a control mouse and in three treated mice presenting different behaviors:

T: control mouse, non-treated

I1: Irradiated mouse, no effect on the development of the parasitemia

I2: Irradiated mouse, temporary improvement

I3: Irradiated mouse which negativates itself.

I'3: Relapse of the mouse I3 approximately 5 days after the negativation

black bar: Irradiation session (of 12 hours)

jours = days

Trypanosomes par ul: trypanosomes per microliter

Table III- Experiment of type A. Evolution of the parasitemia (semi-quantitative evaluation) in mice infested with  $2.0E4$  trypanosomes. Ten non-treated mice serve as control group (group T). Ten other mice are treated by irradiation (group I) and present 3 types of behaviors (I1, I2 and I3).

Top line: Number of days after infestation

Bottom of graph:

The intensity of the parasitemia is indicated in this manner:

- absence of trypanosomes in the blood

+ approximately less than or equal to  $1.0E3$  trypanosomes per microliter of blood

++ approximately  $1.0E4$  trypanosomes per microliter of blood

- +++ approximately 1.0E5 trypanosomes per microliter of blood
- ++++ approximately more than or equal to 1.0E6 trypanosomes per microliter of blood
- \* mouse is dead.

Fig 28 - Treatment by irradiation of the acute trypanosomiasis of the mouse (*T. Equiperdum*) Evolution of the parasitemia (number of trypanosome per microliter of blood) during experiment of type B (device No 1 - HF wavelength: 17 meter - daily irradiations of 12 hours during 5 days) in two mice:

T: non-treated control mouse

I: treated mouse

I': Relapse of the treated mouse, approximately 5 days after the negativation

black bar: session of irradiation (of 12 hours)

jours: days

Trypanosomes par ul: trypanosomes per microliter

Table IV- Experiment of type B. Evolution of the parasitemia (semi-quantitative evaluation) in mice infested with 2.0E4 trypanosomes. Ten mice non-treated serve as control (group T). Ten other mice are treated by irradiation (group I). All the treated mice relapse after negativation (I')

Top line: Number of days after infestation

Bottom of graph:

The intensity of the parasitemia is indicated in this manner:

- absence of trypanosomes in the blood
- + approximately less than or equal to 1.0E3 trypanosomes per microliter of blood
- ++ approximately 1.0E4 trypanosomes per microliter of blood
- +++ approximately 1.0E5 trypanosomes per microliter of blood
- ++++ approximately more than or equal to 1.0E6 trypanosomes per microliter of blood
- \* mouse is dead.

Fig 29 - Treatment by irradiation of the acute trypanosomiasis of the mouse (*T. Equiperdum*) Evolution of the parasitemia (number of trypanosomes per microliter of blood) during an experiment of type C (device No 2 - HF wavelength: 17 meter - daily irradiation of 12 hours during 5 days) in two mice:

T: non-treated control mouse

I: treated mouse

I': Eventual relapse of the treated mouse.

black bar: session of irradiation

In fact, approximately 1/3 of treated and negativated mice do not relapse: they are definitively healed.

jours: days

Trypanosomes par ul: trypanosomes per microliter

Table V - Experiment of type C. Evolution of the parasitemia (semi-quantitative evaluation) in mice infested with 2.0E4 trypanosomes. Ten non-treated mice serve as control (group T). Thirty mice are treated by irradiation (group I). Approximately 2/3 only of mice relapse after negativation (I').  
 N.B. - For typographical reasons, we show results only for 10 treated mice, selected at random).

Top line: Number of days after infestation

Bottom of graph:

The intensity of the parasitemia is indicated in this manner:

- absence of trypanosomes in the blood
- + approximately less than or equal to 1.0E3 trypanosomes per microliter of blood
- ++ approximately 1.0E4 trypanosomes per microliter of blood
- +++ approximately 1.0E5 trypanosomes per microliter of blood
- ++++ approximately more than or equal to 1.0E6 trypanosomes per microliter of blood
- \* mouse is dead.

Fig 30 - Treatment by irradiation of the acute trypanosomiasis of the mouse (*T. Equiperdum*)  
 Influence of the infesting dose - Experiment E.  
 Evolution of the parasitemia (number of trypanosomes per microliter of blood) in 4 groups of mice:

T1: Ten control mice      )(  
   )( infested with 2.0E5 trypanosomes  
 I1: Thirty irradiated mice   )(  
  
 T1: Ten control mice      )(  
   )( infested with 2.0E6 trypanosomes  
 I1: Thirty irradiated mice   )(

Numbers between parenthesis show the number of mice alive during the exams, at the beginning and at the end of the experiment.

Black bar: one session of irradiation (of 6 hours)

Fig 31 - Treatment by irradiation of the acute trypanosomiasis of the mouse (*T. Equiperdum*).  
 Influence of the time of start of treatment. Experiment F.  
 Evolution of the parasitemia (number of trypanosomes per microliter of blood) in 5 groups of mice infested with 2.0E4 parasites (groups T, I1, I2, I3 and I4).  
 Device No 2. Daily sessions of irradiation of 6 hours.

T: 10 non-treated control mice.  
 I1, I2, I3 and I4: four groups of 30 treated mice. The first sessions of irradiation start respectively 2, 24 48 and 72 hours after the infestation.

Numbers between parenthesis show the number of mice alive during the exams, at the beginning and at the end of the experiment, and during the experiment in case of variation.

Black bar: session of irradiation (of 6 hours)

Fig 32 - Treatment by irradiation of the acute trypanosomiasis of the mouse (*T. Equiperdum*). Influence of the distance of animals relative to the axis of the device. Diagram of the cage and of its position relative to the device. Experiment L.

Bobine magnétisante: magnetic coil

Cage laiton (10 cases): brass cage (10 cases)

Tube: tube

Bobine: Coil

Cage: cage

Fig 33 - Treatment by irradiation of the acute trypanosomiasis of the mouse (*T. Equiperdum*) Influence of the distance of animals relative to the axis of the device. Diagram of the cage. The 10 lodges (semi-circular, circular and cylindrical) are numbered from the periphery toward the center. Experiment M.

Fig 34 - Treatment by irradiation of the acute trypanosomiasis of the mouse (*T. Equiperdum*) Influence of the distance of the animals relative to the axis of the device. Experiment M. Evolution of the parasitemia in mice placed in the lodges of the cage. The numbers (from 1 to 10) correspond to 10 lodges (for their position, see fig 33).

T: non-treated control mouse

souris: mouse

“et” = “and”

Fig 35 - Treatment by irradiation of the chronic trypanosomiasis of the rabbit (*T. Equiperdum*). Effect of a treatment started 2 hours after the infestation. Case of rabbit RQ80. Infested with  $5.0E6$  trypanosomes. Treated during 10 days, daily sessions of 10 hours. Experiment X. Evolution of the parasitemia, of the ratio albumin/globulins and of immunoglobulins M (IgM) and G (IgG). The level of immunoglobulins is expressed in multiples of the level existing before the experiment.

Black triangle: infestation

Black bar: duration of treatment

- absence of trypanosomes in the blood.

Fig 36 - Treatment by irradiation of the chronic trypanosomiasis of rabbit (*T. Equiperdum*). Effect of a treatment started 2 hours after the infestation. Case of rabbit RQ80. Experiment X - see figure 35 - Evolution of precipitants antibodies (Ac. Precip.), agglutinants antibodies (Ac. Aggl.) and of hemagglutinants antibodies (Ac. Hemaggl). Their level is expressed by the inverse of the last dilution still giving a positive reaction.

Black triangle: infestation  
Black bar: duration of treatment  
- absence of trypanosomes in the blood.

Fig 37 - Treatment by irradiation of the chronic trypanosomiasis of rabbit (T. Equiperdum).  
Effect of a treatment started 2 weeks after the infestation.  
Case of rabbit RQ85. Infested with  $5.0E6$  trypanosomes, treated during 15 days (daily sessions of 10 hours). Experiment Y.  
Evolution of the parasitemia, of the albumin/globulins ratio and of the immunoglobulins M (IgM) and G (IgG). The level of immunoglobulins is expressed in multiples of the level existing before the experiment.

Black triangle: infestation  
Black bar: duration of treatment  
+ presence of trypanosomes in the blood  
- absence of trypanosomes in the blood

Fig 38 - Treatment by irradiation of the chronic trypanosomiasis of rabbit (T. Equiperdum).  
Effect of a treatment started 2 weeks after the infestation.  
Case of rabbit RQ85. Experiment Y - See previous figure.  
Evolution of precipitants antibodies (Ac. Precip.), agglutinants antibodies (Ac. Aggl.) and of hemagglutinants antibodies (Ac. Hemaggl). Their level is expressed by the inverse of the last dilution still giving a positive reaction.

Black triangle: infestation  
Black bar: duration of treatment  
+ presence of trypanosomes in the blood  
- absence of trypanosomes in the blood

Fig 39 - Treatment by irradiation of the chronic trypanosomiasis of the rabbit (T. Equiperdum)  
Clinical aspect of 2 rabbits, four weeks after their infestation with  $5.0E6$  trypanosomes.  
The rabbit on the left has not been treated.  
The rabbit on the right was put under treatment after 15 days of evolution of the disease.  
The treatment lasted 15 days (daily sessions of irradiation of 10 hours).  
Rabbit RQ85 (see figures 37 and 38) - Experiment Y).  
The photo was taken at the time of stop of the treatment.

Fig 40 - Treatment by irradiation of the chronic trypanosomiasis of the rabbit (T. Equiperdum)  
Effect of treatment on testicular lesions.  
Case of rabbit RR20. Infested with  $5.0E6$  trypanosomes. Treatment of 15 days (daily sessions of 10 hours), started 15 days after the infestation. See experiment Y.  
The testicular gland is collected 14 days after the stop of the treatment, i.e. 44 days after the infestation. Histological aspect:

a: seminal tubes (magnifying power  $10 \times 3.2$ )  
b: seminal tubes (magnifying power  $40 \times 3.2$ )  
c: epididymal tubes (magnifying power  $4 \times 3.2$ )

d: epididymal tubes (magnifying power 25 x 3.2)

Fig 41 - Treatment by irradiation of the chronic trypanosomiasis of the rabbit (*T. Equiperdum*)  
Effect of treatment on testicular lesions.

Case of rabbit RQ85 (see Fig 37 and 38 - Experiment Y).

Treatment of 15 days (daily sessions of 10 hours), started 15 days after the infestation.

Clinical and biological healing.

The testicular gland is collected 7 months after the stop of the treatment.

Histological aspect:

a: seminal tubes (magnifying power 10 x 3.2)

b: seminal tubes (magnifying power 40 x 3.2)

c: epididymal tubes (magnifying power 4 x 3.2)

d: epididymal tubes (magnifying power 25 x 3.2)

Fig 42 - Treatment by irradiation of the chronic trypanosomiasis of the rabbit (*T. Equiperdum*).  
Evolution of the body temperature (rectal) in 2 rabbits infested with  $5.0E6$  trypanosomes. One of the rabbit is not treated and serves as control. The other rabbit is placed under treatment 2 hours after the infestation (treatment of 10 days, daily session of 10 hours - Rabbit RQ80 of experiment X. See Figures 35 and 36).

Temperature: temperature

Lapin Témoin: Control rabbit

Lapin Irradié: Irradiated rabbit

Fig 43 - Effect of reinfestations in a rabbit previously infested and treated. Evolution of the serous level of immunoglobulins M (IgM) and G (IgG). These levels are expressed in multiples of levels existing before the experiment.

Experiment AC.

Case of rabbit RR13. Infested with  $5.0E7$  trypanosomes, then treated during 10 days (daily session of 10 hours, first session starting 2 hours after the infestation). Ten days after stopping this first treatment, a first reinfestation with  $2.0E8$  trypanosomes is accompanied by a reduced treatment (2 sessions of irradiation of 10 hours, every other day, the first session starting 2 hours after the reinfestation). A second reinfestation is performed 25 days later, also with  $2.0E8$  trypanosomes, but without treatment.

Black triangle: infestation

Black bar: duration of treatment

+ presence of trypanosomes in the blood

- absence of trypanosomes in the blood

Fig 44 - Effect of reinfestations in a rabbit previously infested and treated.

Case of rabbit RR13 - Experiment AC - see previous figure - Evolution of the circulating antibodies of precipitants (Ac. Precip.), agglutinants (Ac. Aggl.) and hemagglutinants (Ac. Hemaggl.). Their level is expressed by the inverse of the last dilution still giving a positive reaction.



Black triangle: infestation and reinfestations  
Black bar: Duration of treatment  
+ Presence of trypanosomes in blood  
- Absence of trypanosomes in blood

Fig 45 - Effect of reinfestations in a trypanosomed rabbit (T. Equiperdum) healed by the radiation.

Evolution of the serous level of immunoglobulins G (IgG) and M (IgM). These levels are expressed in multiples of levels existing before the experiment. Experiment AC - Case of rabbit RQ86. Infested with 2.0E8 trypanosomes.

After 24 days of disease, treatment during 21 days (daily sessions of 10 hours). Two reinfestations are performed tardily: on the 338th and 360th days after the primary infestation, the first with 2.0E8 trypanosomes and the second with 1.0E9 trypanosomes. Each reinfestation is accompanied by a reduced treatment (2 sessions of 10 hours, every other day, the first starting 2 hours after the reinfestation).

Black triangle: infestation and reinfestations  
Black bar: Duration of treatment  
+ Presence of trypanosomes in blood  
- Absence of trypanosomes in blood

Fig 46 - Effect of reinfestations in a trypanosomed rabbit (T. Equiperdum), healed by the radiation.

Evolution of the circulating antibodies of precipitants (Ac. Précip.), agglutinants (Ac. Aggl.) and hemagglutinants (Ac. Hémaggl.). Their level is expressed by the last dilution still giving a positive reaction.

Case of rabbit RQ86 (see previous figure).

Black triangle: infestation and reinfestations  
Black bar: Duration of treatment  
+ Presence of trypanosomes in blood  
- Absence of trypanosomes in blood

Fig 47 - Confirmation of the immunoglobulinic nature of the sero-protective power.

Experiment AD. We chose rabbit RR15. Infested with 9.0E7 trypanosomes, then treated during 10 days (daily sessions of 10 hours, the first session starting 2 hours after the infestation). Four infestations are performed, each accompanied by a reduced treatment (2 sessions of irradiation of 10 hours, with delay of one day, the first starting 2 hours after the first reinfestation).

Cadence of the 4 reinfestations:

1st: 26th day after the infestation, with 2.0E8 trypanosomes  
2nd: 53rd day after the infestation, with 1.5E9 trypanosomes  
3rd: 257th day after the infestation, with 2.0E8 trypanosomes  
4th: 272nd day after the infestation, with 1.0E9 trypanosomes

Evolution of the serous level of immunoglobulins G (IgG) and M (IgM). These levels are expressed in multiples of the levels existing before the experiment.

Black triangle: infestation and reinfestations  
Black bar: Duration of treatment  
- Absence of trypanosomes in blood

Fig 48 - Confirmation of the immunoglobulinic nature of the sero-protective power.  
Experiment AD. We have chosen rabbit RR15 - see previous figure - Evolution of the antibodies of precipitants (Ac. Précip.), agglutinants (Ac. Aggl.) and hemagglutinants (Ac. Hemaggl.). Their level is expressed by the inverse of the dilution still giving a positive reaction.

Black triangle: infestation and reinfestations  
Black bar: Duration of treatment  
- Absence of trypanosomes in blood

Fig 49 - Confirmation of the immunoglobulinic nature of the sero-protective power shown by the serum of rabbit RR15 (see figures 47 and 48). Experiment AD.  
Four samples of the serum were analysed by ultra-centrifugation; 0.4 milliliter of each sample was deposited on top of a gradient of saccharose (5 to 25%):

sample N: before the infestation  
sample A: 18 days after the 1st reinfestation  
sample B: 7 days after the 2nd reinfestation  
sample C: 15 days after the 2nd reinfestation

See text for the experimental details. Twelve fractions of 1 milliliter were collected. Fraction No. 1 corresponds to the bottom of the gradient. The levels of G and M immunoglobulins are expressed in conventional units, in referring to a personal benchmark containing by definition 100 units of each immunoglobulin. The protective power is indicated by a dotted area when it is partial, by a hashed area when it is total.

Fig 50 - Treatment by irradiation of the chronic trypanosomiasis of the mouse (*T. Gambiense*).  
Experiment AE.  
Evolution of the parasitemia (number of trypanosomes per microliter of blood) and of the serous level of IgM in a mouse infested with  $1.0E3$  trypanosomes and placed under treatment 11 days later. Treatment of 9 days (daily sessions of 6 hours). The level of IgM is expressed in multiples of the level existing before the infestation. In the case of this mouse, the trypanosomes disappear from the peripheral blood, and the level of IgM normalizes itself rapidly. Afterward, this level raises again. Approximately 4 months later, trypanosomes reappear in the blood and the animal dies.

Black triangle: infestation  
Black bar: duration of treatment

Fig 51 - Treatment by irradiation of the chronic trypanosomiasis of the mouse (*T. Gambiense*)  
Experiment AE. Evolution of the parasitemia (number of trypanosomes per microliter of blood) and of the serous level of IgM in a mouse placed under treatment 11 days after its infestation (with  $1.0E3$  trypanosomes). Treatment of 9 days (daily sessions of 6

hours). The level of IgM is expressed in multiples of the level existing before the infestation. In the case of this mouse, the trypanosomes disappear definitively from the peripheral blood, and the level of IgM normalizes itself rapidly and definitively. Healing.

Black triangle: infestation and reinfestations

Black bar: Duration of treatment

Fig 52 - Treatment by irradiation of the paludism in mouse (P. Berghei).

Evolution of the parasitemia in 2 groups of 30 mice each infested with  $1.0E4$  parasites. The mice of the first group are not treated and serve as control. The mice of the other group are treated during 10 days (daily sessions of irradiation of 6 hours, the first session starting 2 hours after the infestation).

Semi-quantitative evaluation of the parasitemia (proportion of red blood cells parasited by endo-erythrocytic forms, expressed in %). Experiment AG.

The control mice die around the 15th day.

The treated mice die around the 20th day.

Témoins: control

Traités: treated

TABLEAU I

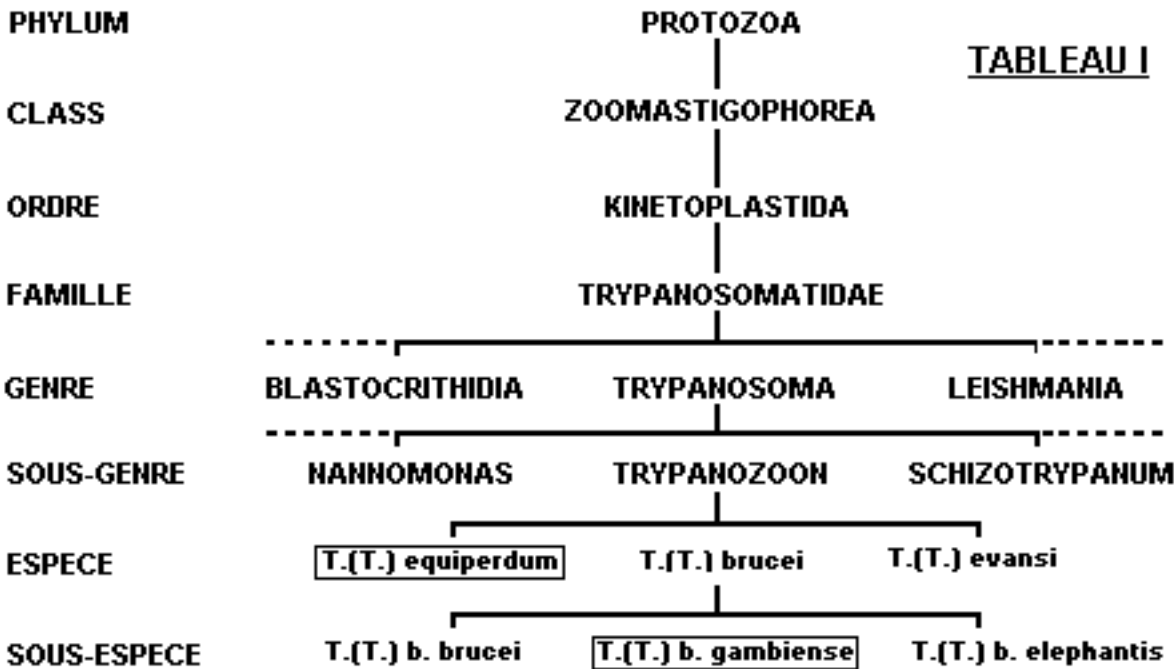

Système immunologique	Les antigènes sont:		Les anticorps sont de nature:	
	spécifiques de type antigénique	communs à tous les types antigéniques	IgM	IgG
Agglutination	+	-	+ et +	
Hémagglutination	-	+	? +	
Précipitation	+ et -	+ et -	- +	
Séro-protection	+	-	? +	

TABLEAU II

Nombre de jours après l'infestation

1	2	3	4	5	6	7	8	9	10	11	12	13	14	15	16
---	---	---	---	---	---	---	---	---	----	----	----	----	----	----	----

TABLEAU III

T	{	1	-	##	###	####	*									
		2	+	##	###	*										
		3	-	+	###	*										
		4	+	##	####	*										
		5	+	###	####	*										
		6	+	##	####	*										
		7	+	##	###	*										
		8	+	##	####	*										
		9	-	+	###	####	*									
		10	-	##	####	*										

I	{	I <sub>1</sub>	{	1	-	##	###	####	*									
				2	+	##	####	*										
		I <sub>2</sub>	{	3	+	##	###	+	+	##	###	*						
				4	-	+	###	+	##	###	####	*						
				5	+	##	####	+	+	##	###	*						
		I <sub>3</sub>	{	6	-	##	###	+	-	-	-	-	-	-	+	##	####	*
				7	+	###	####	+	-	-	-	-	-	-	-	##	###	*
				8	+	##	####	+	-	-	-	-	+	##	####	*		
				9	-	##	###	+	-	-	-	-	##	##	*			
				10	-	##	####	+	-	-	-	-	-	##	####	*		

}

Nombre de jours après l'infestation

1	2	3	4	5	6	7	8	9	10	11	12	13	14	15	16
---	---	---	---	---	---	---	---	---	----	----	----	----	----	----	----

TABLEAU IV

T	1	-	+	++	*												
	2	+	+	+++	*												
	3	-	+	++	*												
	4	+	+	++	*												
	5	-	+	++	+++	*											
	6	+	+	++	+++	*											
	7	-	+	++	*												
	8	+	+	+++	*												
	9	+	+	++	+++	*											
	10	-	+	+++	*												
I	1	+	+	+++	-	-	-	-	-	+	+	++	*				
	2	-	+	++	-	-	-	-	-	-	+	++	++	*			
	3	-	+	++	+	-	-	-	-	-	+	+	++	++	*		
	4	+	+	++	-	-	-	-	-	-	-	+	++	++	*		
	5	+	+	+++	+	-	-	-	-	-	-	+	++	+++	*		
	6	-	+	+++	+	-	-	-	-	-	-	-	-	+	+	+++	*
	7	-	+	++	-	-	-	-	-	-	-	-	-	-	+	++	*
	8	+	+	++	+	-	-	-	-	-	-	-	+	+	++	*	
	9	+	+	++	-	-	-	-	-	-	-	+	++	*			
	10	+	+	+++	-	-	-	-	-	-	+	++	+++	*			

Nombre de jours après l'infestation

1	2	3	4	5	6	7	8	9	10	11	12	13	14	15	16
---	---	---	---	---	---	---	---	---	----	----	----	----	----	----	----

TABLEAU V

T	1	-	+	++	+++	*											
	2	+	++	+++	*												
	3	-	+	++	*												
	4	+	++	++	*												
	5	+	++	+++	*												
	6	+	++	+++	*												
	7	+	++	++	*												
	8	+	++	+++	*												
	9	-	+	++	+++	*											
	10	+	++	++	*												
I	1	+	+++	-	-	-	-	-	-	-	-	-	-	-	-	-	
	2	+	+++	-	-	-	-	-	-	-	-	-	-	-	-	-	
	3	-	++	-	-	-	-	-	-	-	-	-	-	-	-	-	
	4	-	++	-	-	-	-	+	++	+++	*						
	5	+	+++	-	-	-	-	-	++	+++	+++	*					
	6	-	+++	-	-	-	-	-	+	++	+++	*					
	7	+	+++	-	-	-	-	-	-	+	++	+++	+++	*			
	8	+	++	-	-	-	-	-	-	++	+++	+++	*				
	9	+	+++	-	-	-	-	-	-	-	-	-	-	+	++	+++	*
	10	+	+++	-	-	-	-	-	-	-	-	-	-	+	++	+++	*



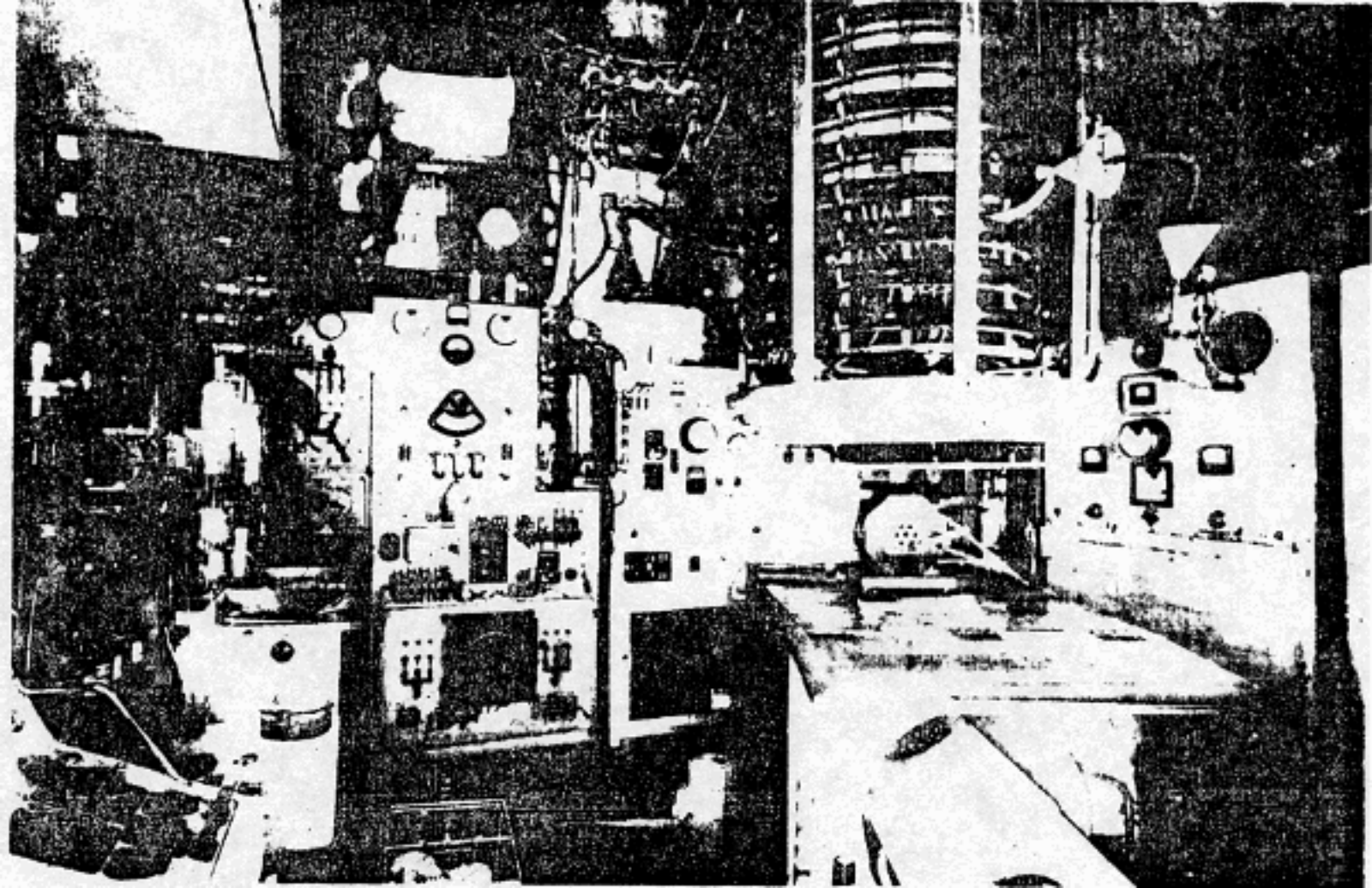

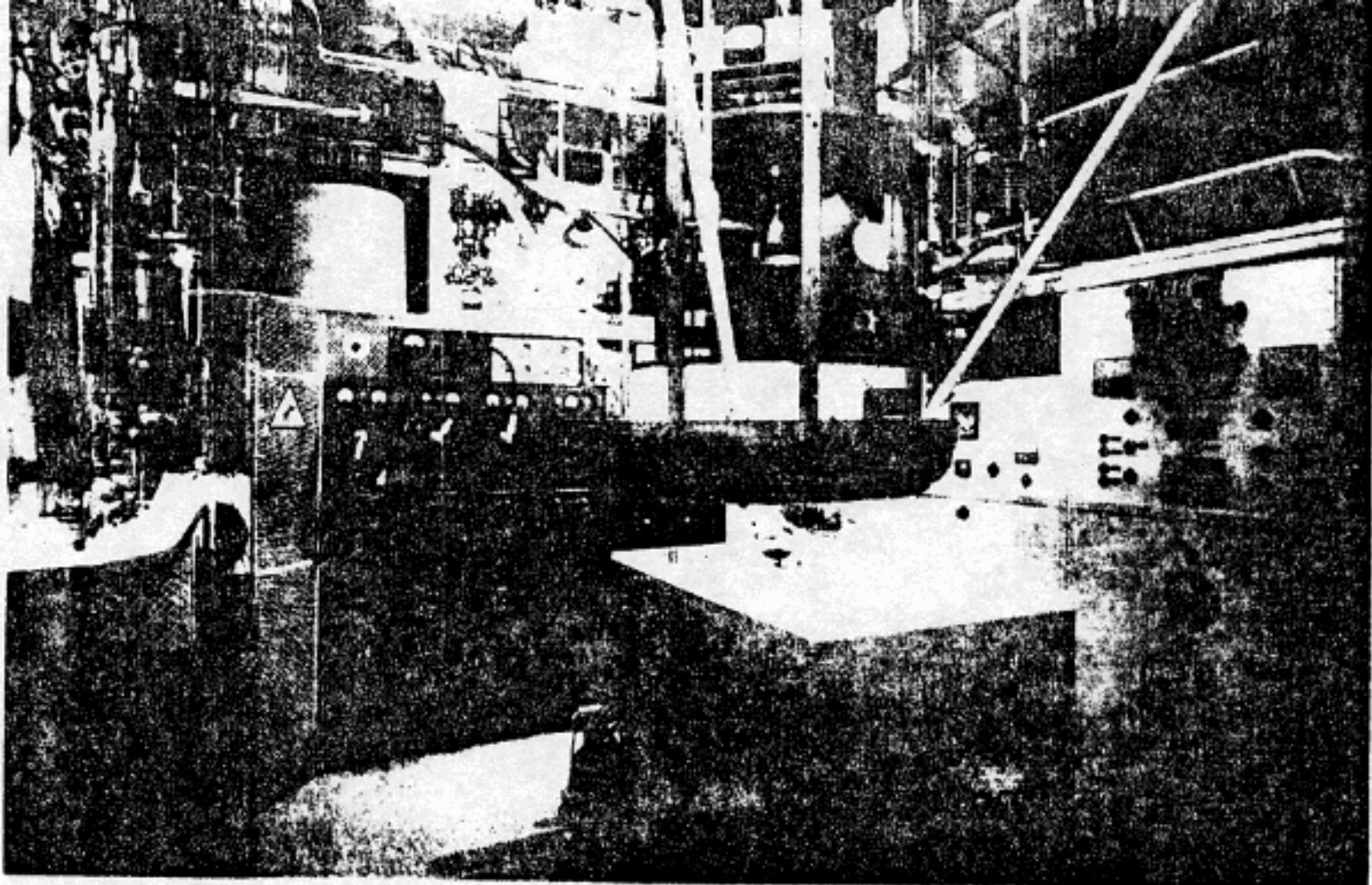
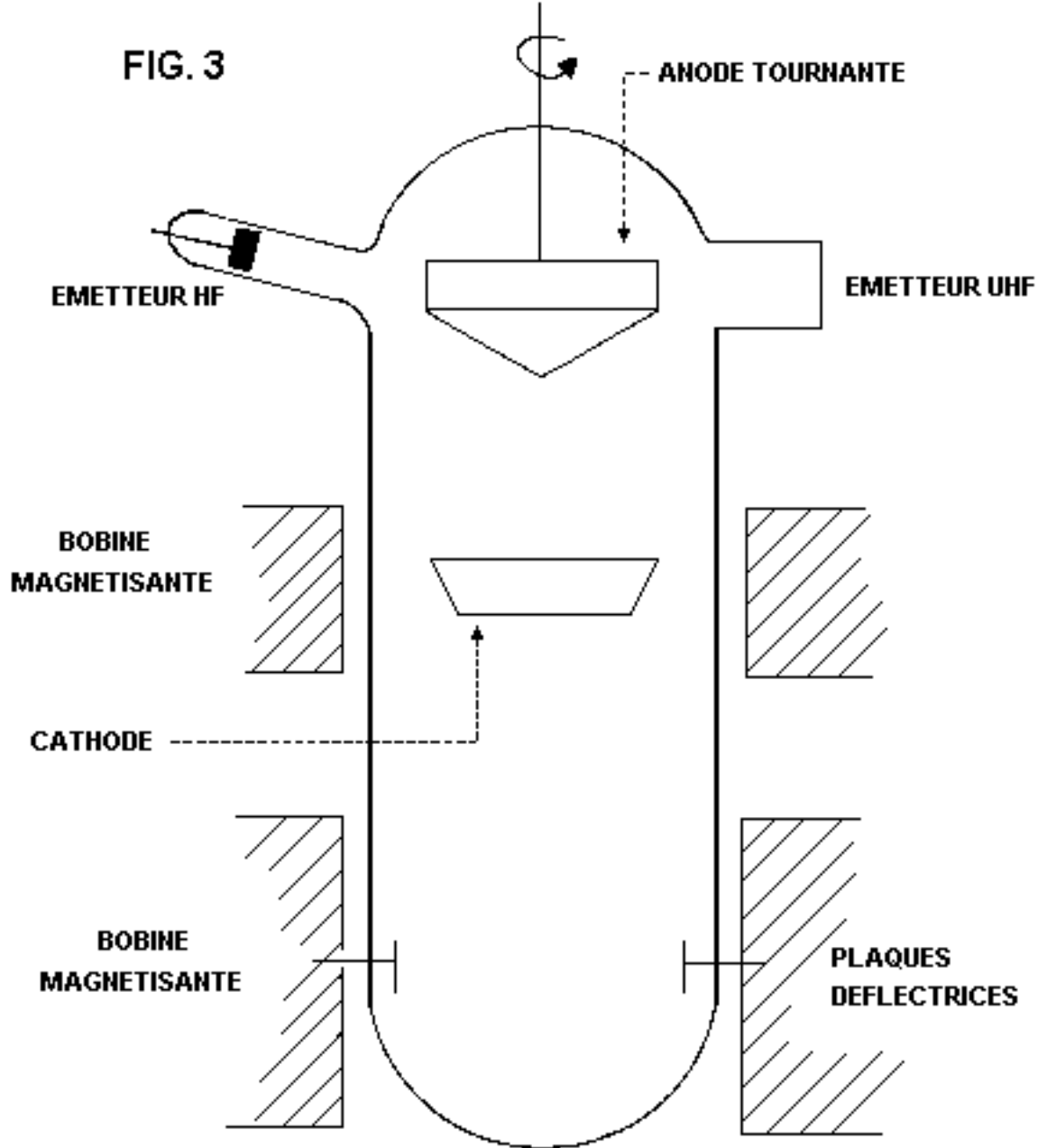

FIG. 3



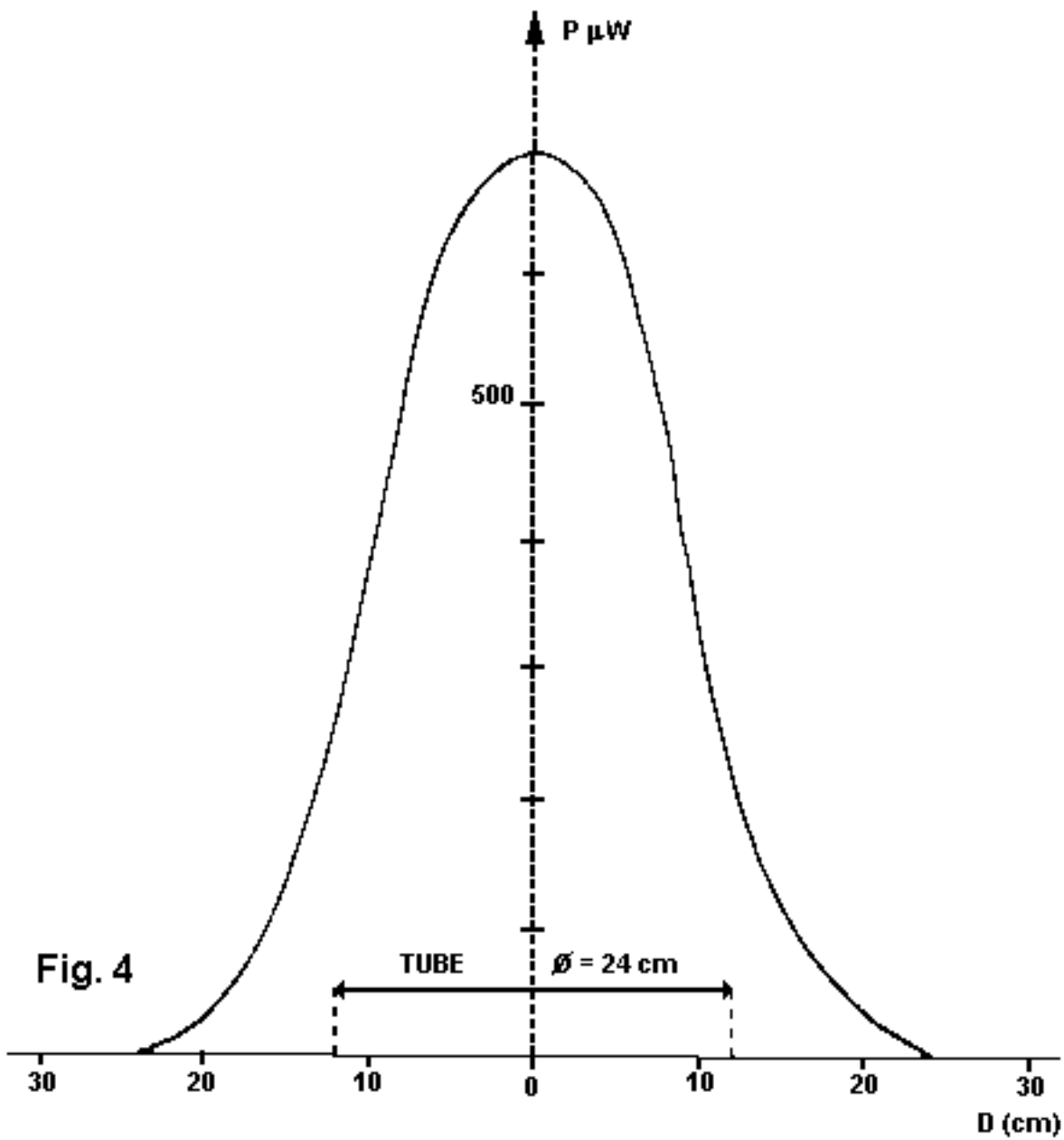
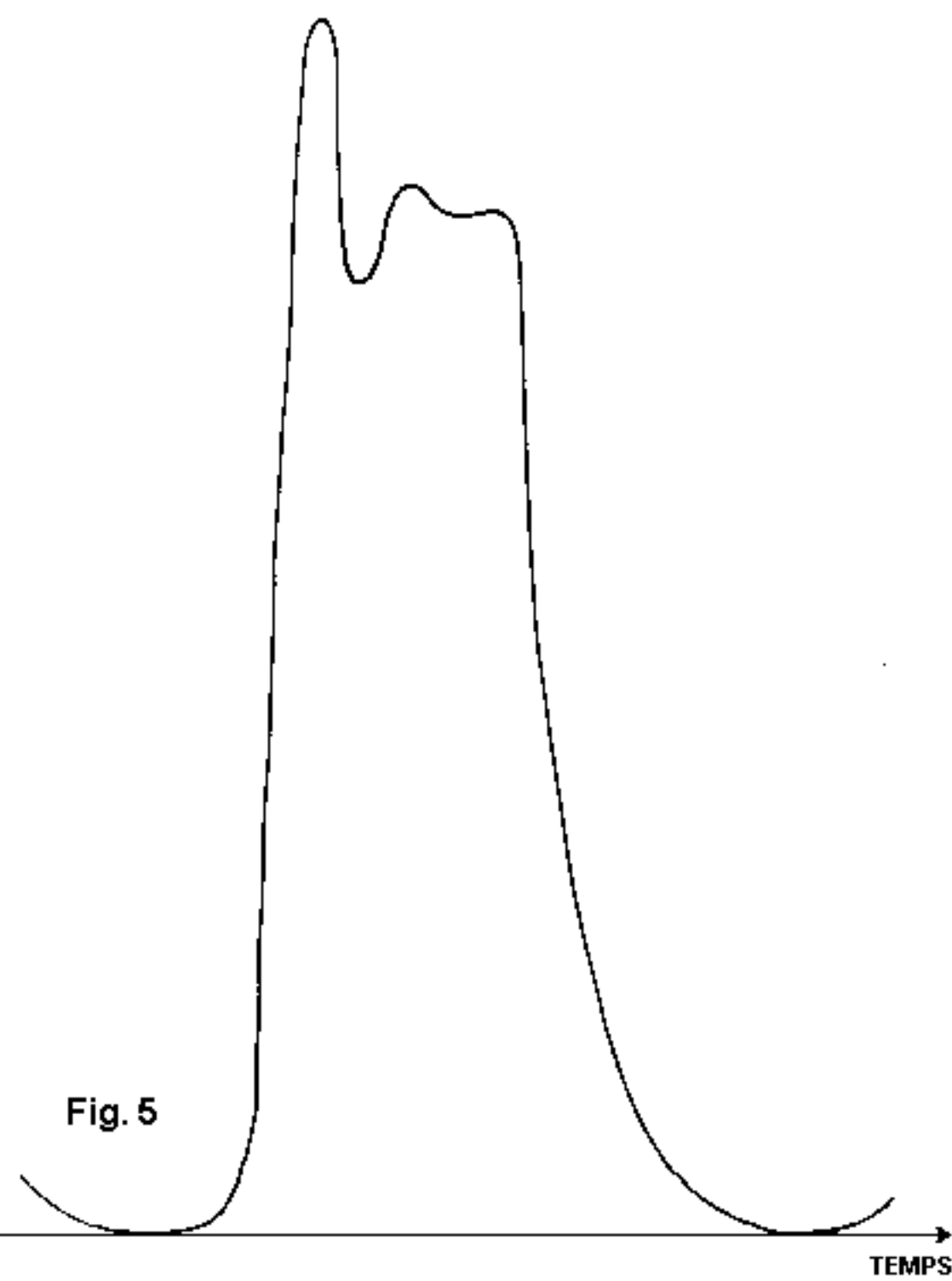
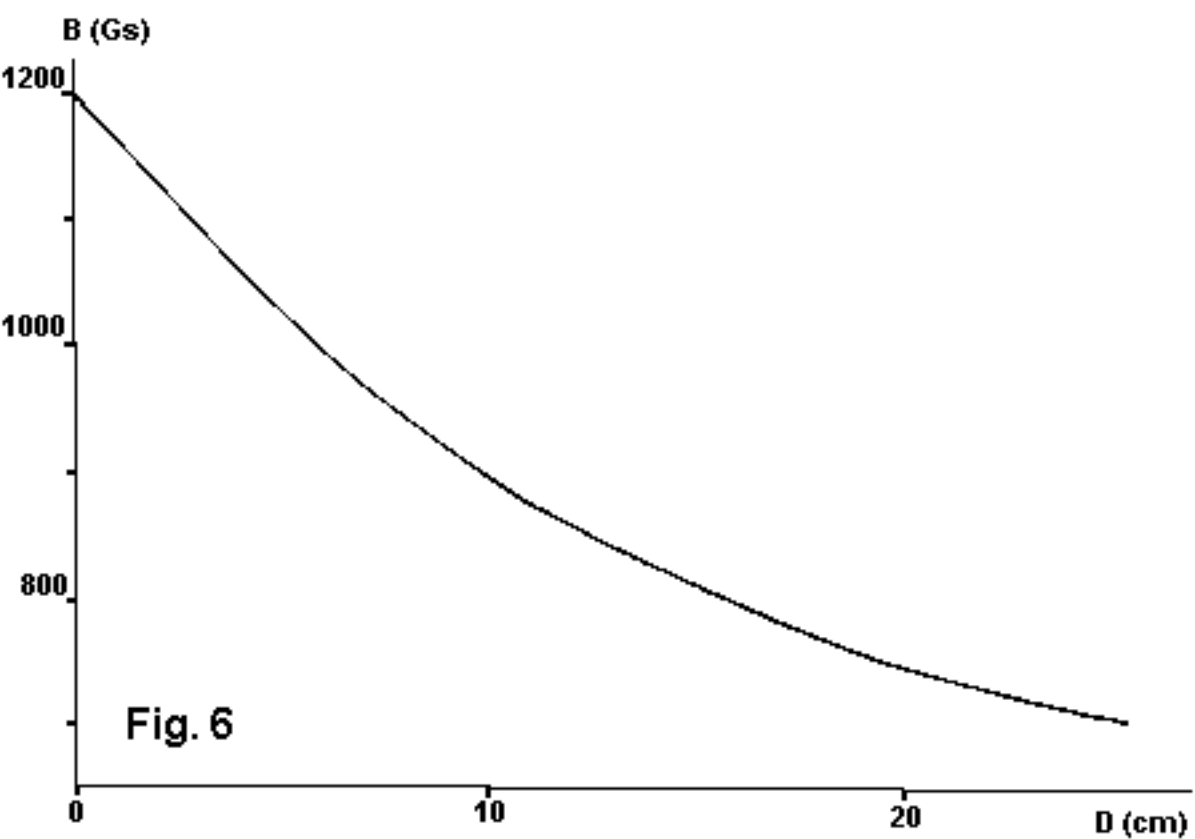

Fig. 4

Fig. 5



TEMPS



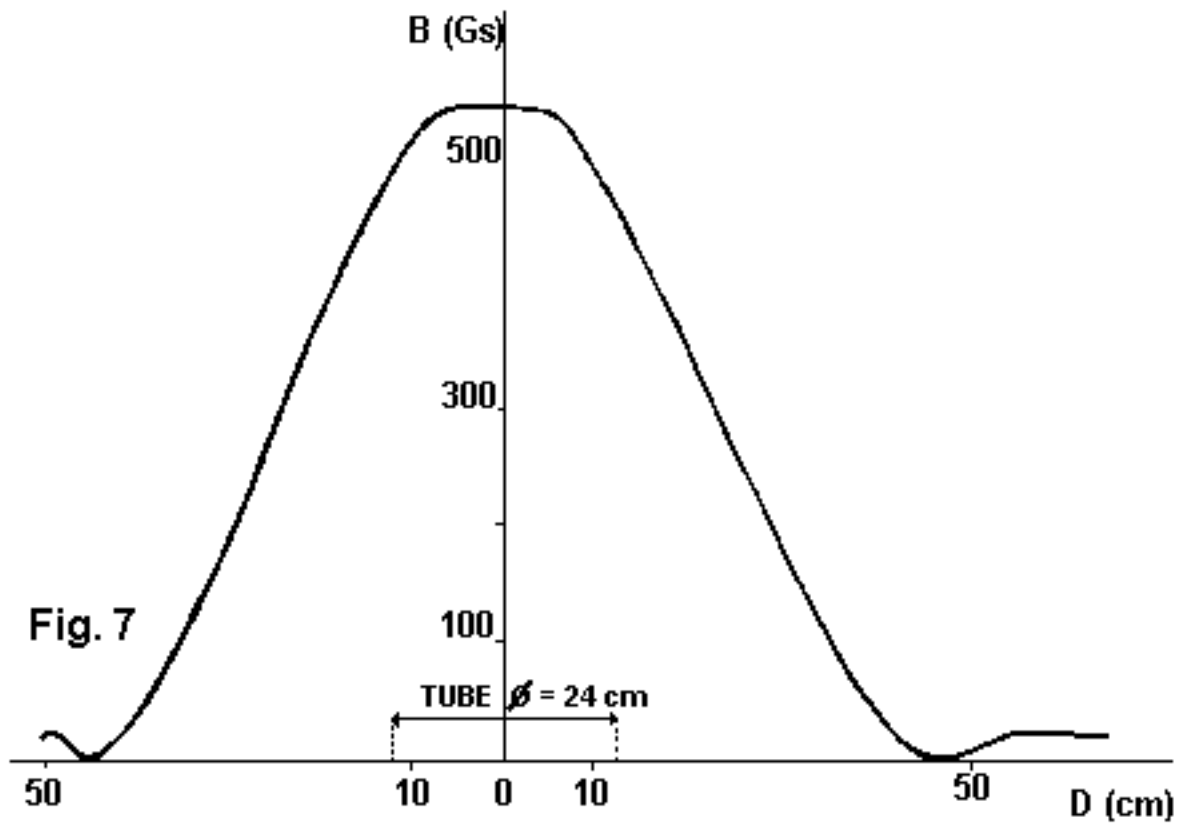

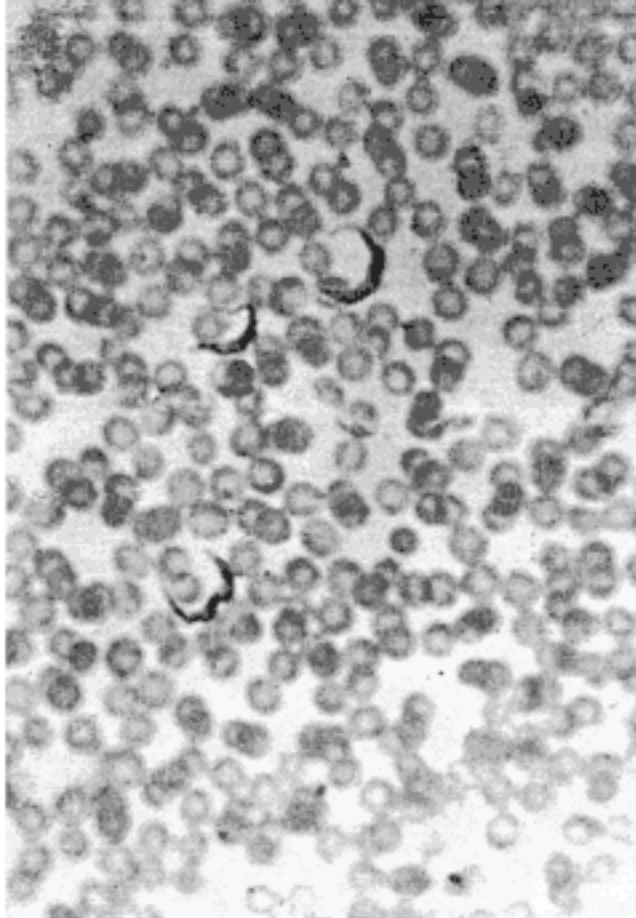

a

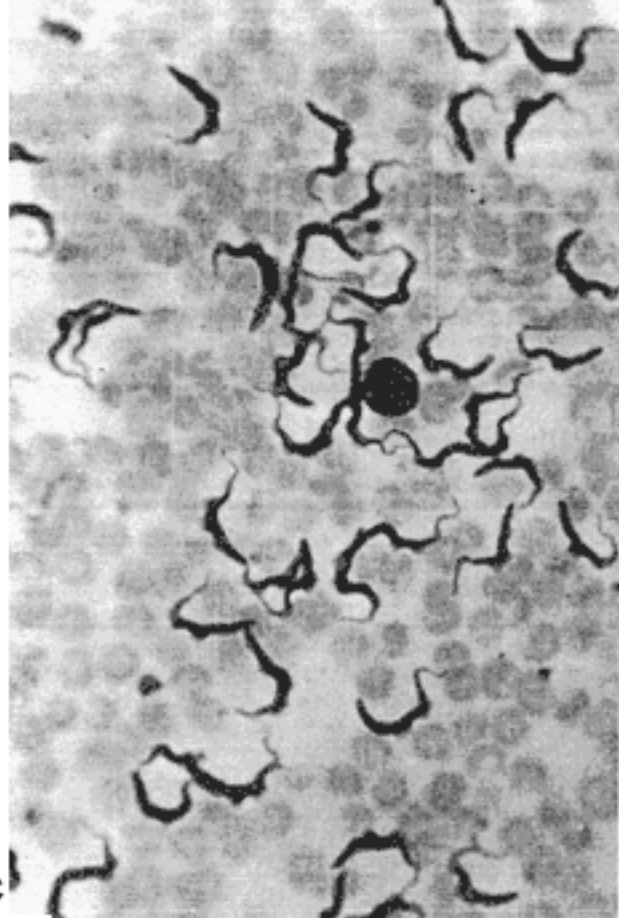

c

Fig. 8

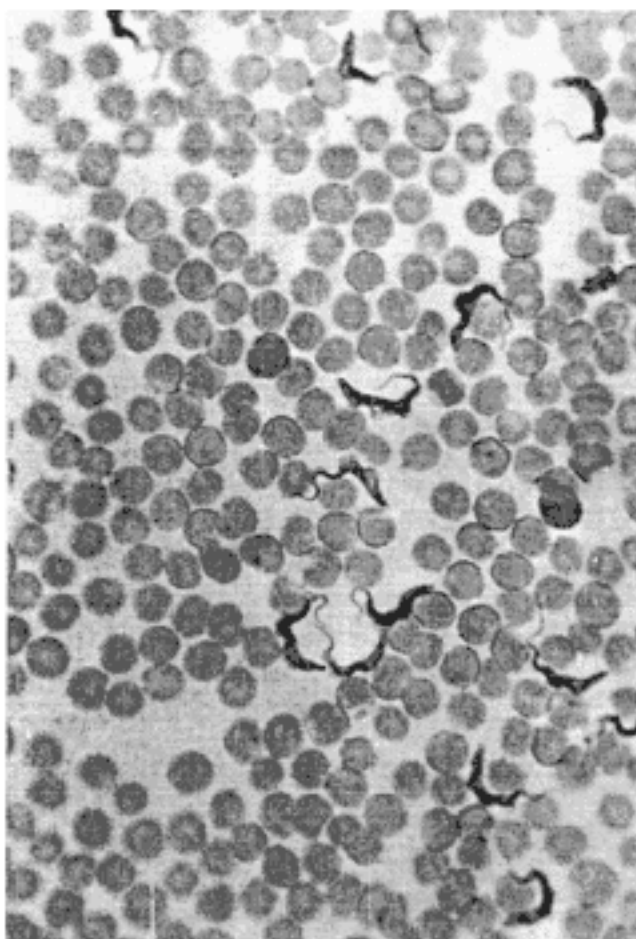

b

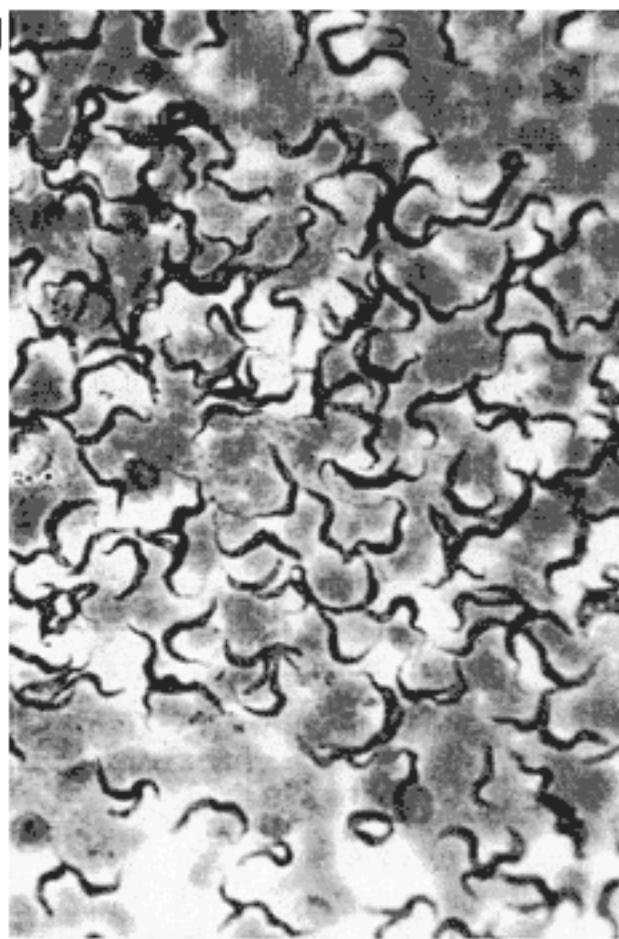

d



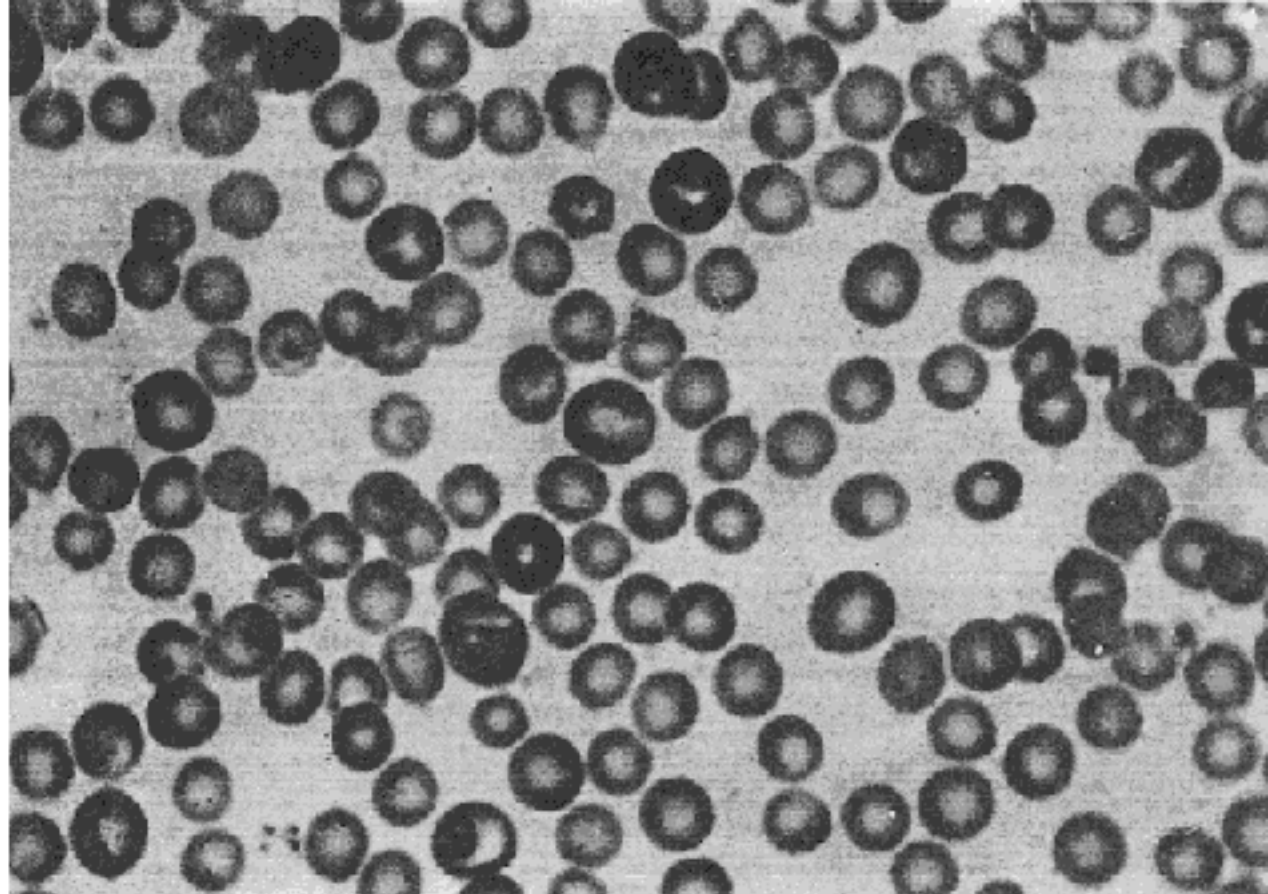

a

Fig. 9

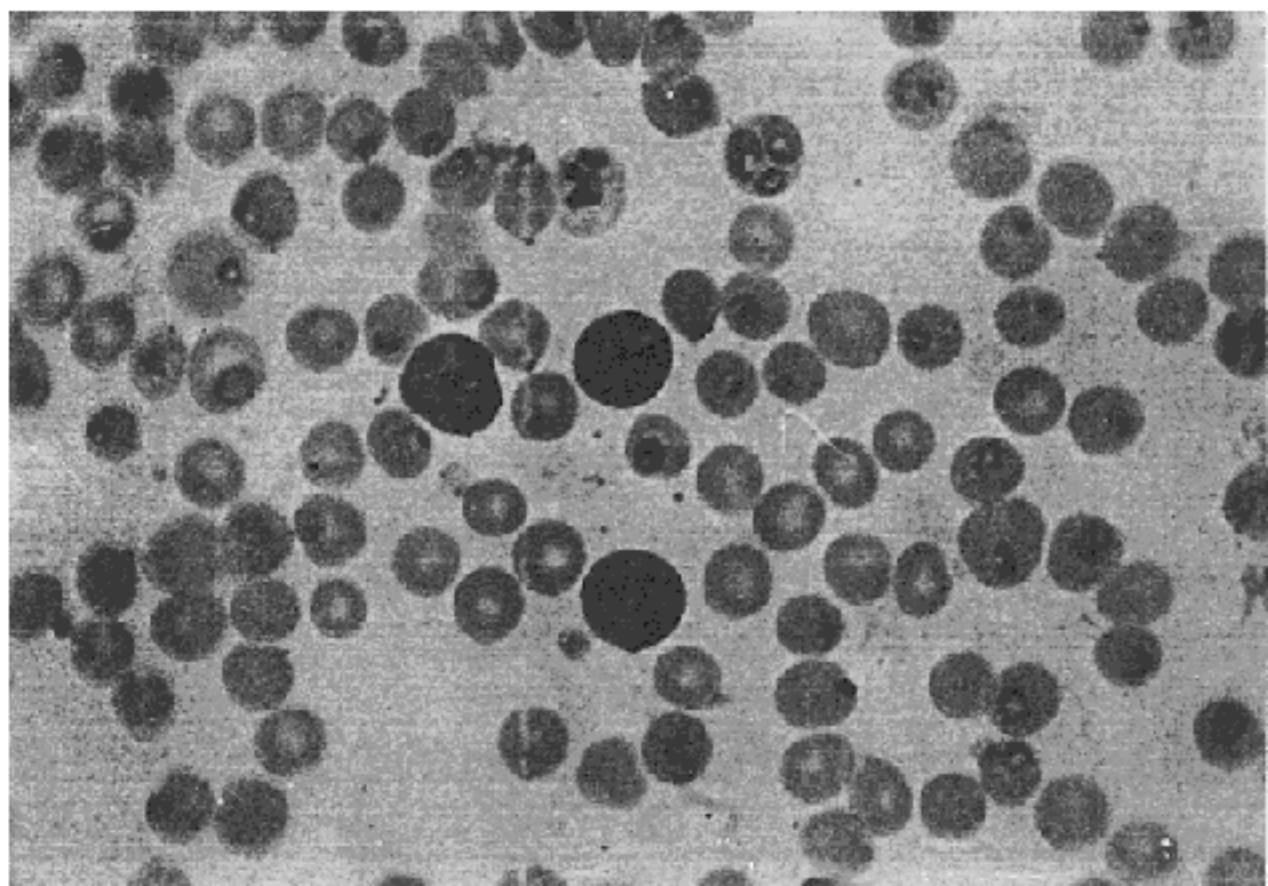

b

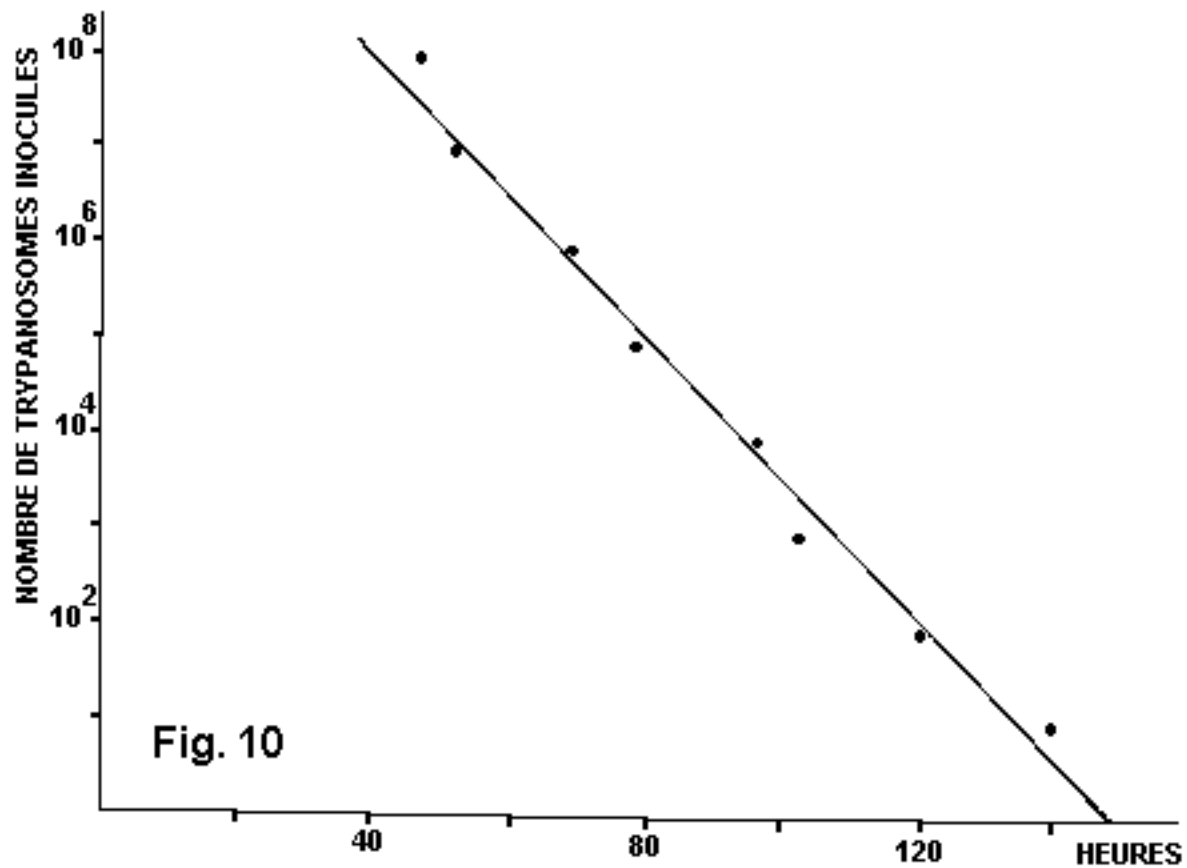

Trypanosomes  
par  $\mu$ l

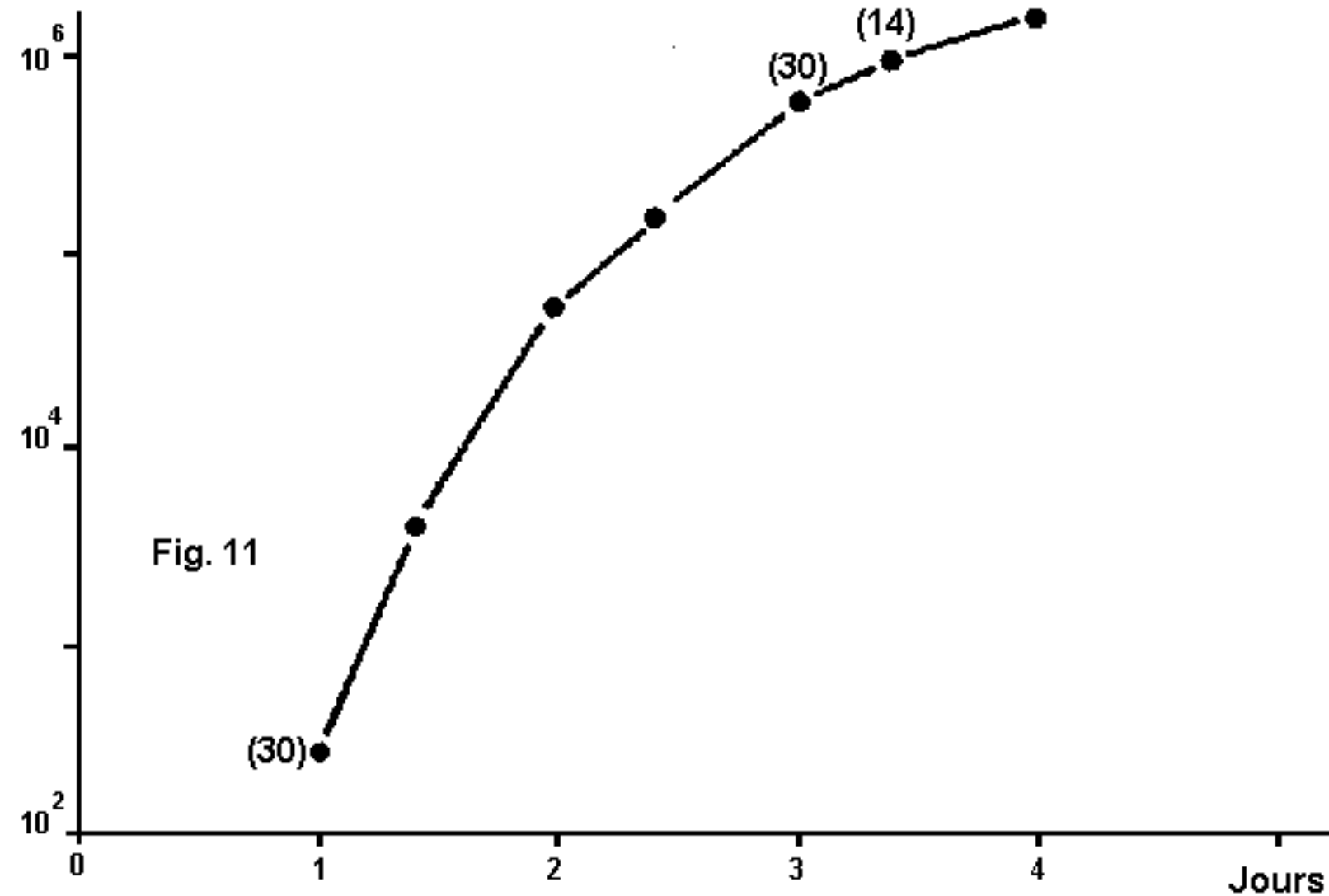

Trypanosomes  
par  $\mu$ l

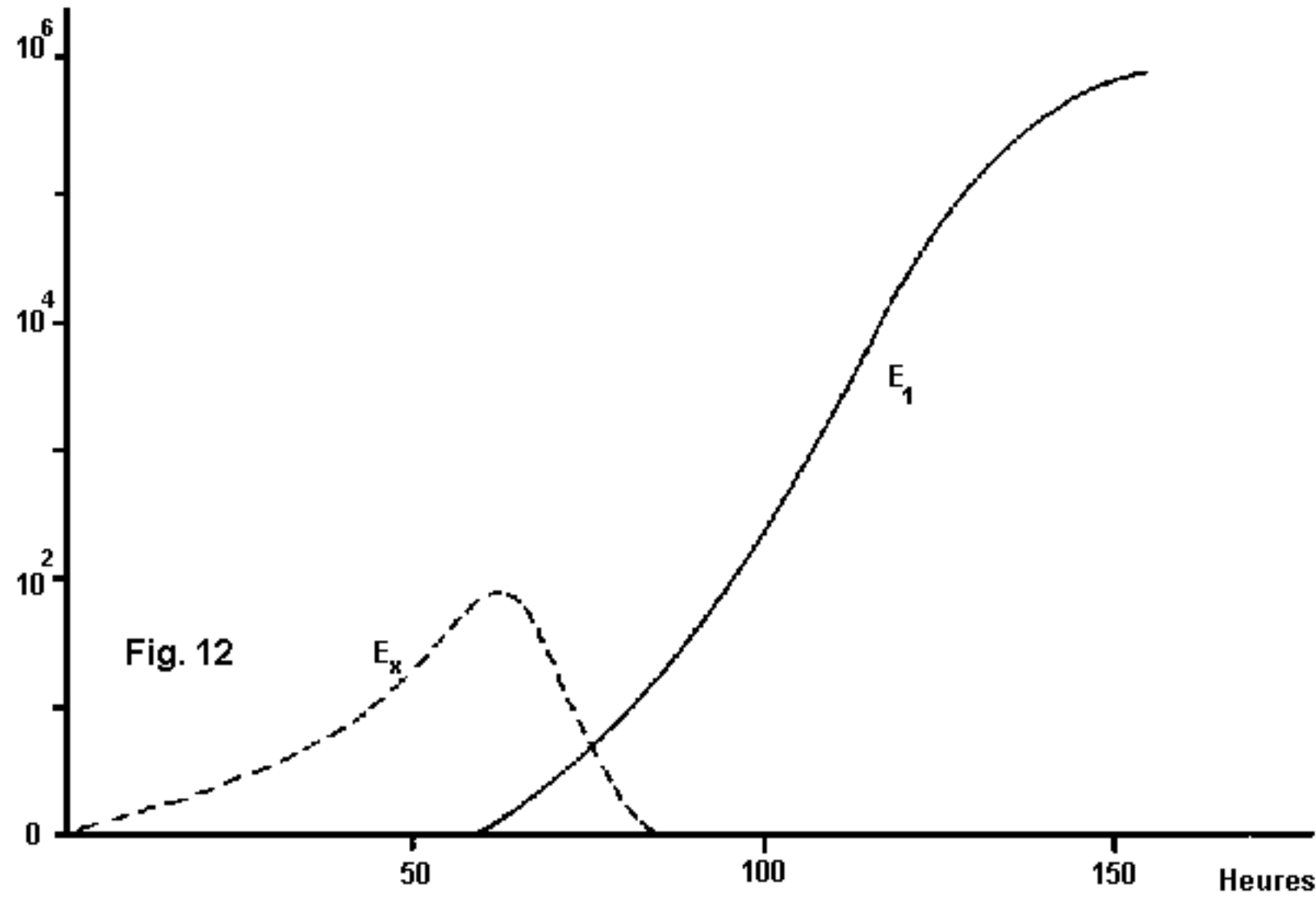

Fig. 12

$E_x$

$E_1$

Heures

41

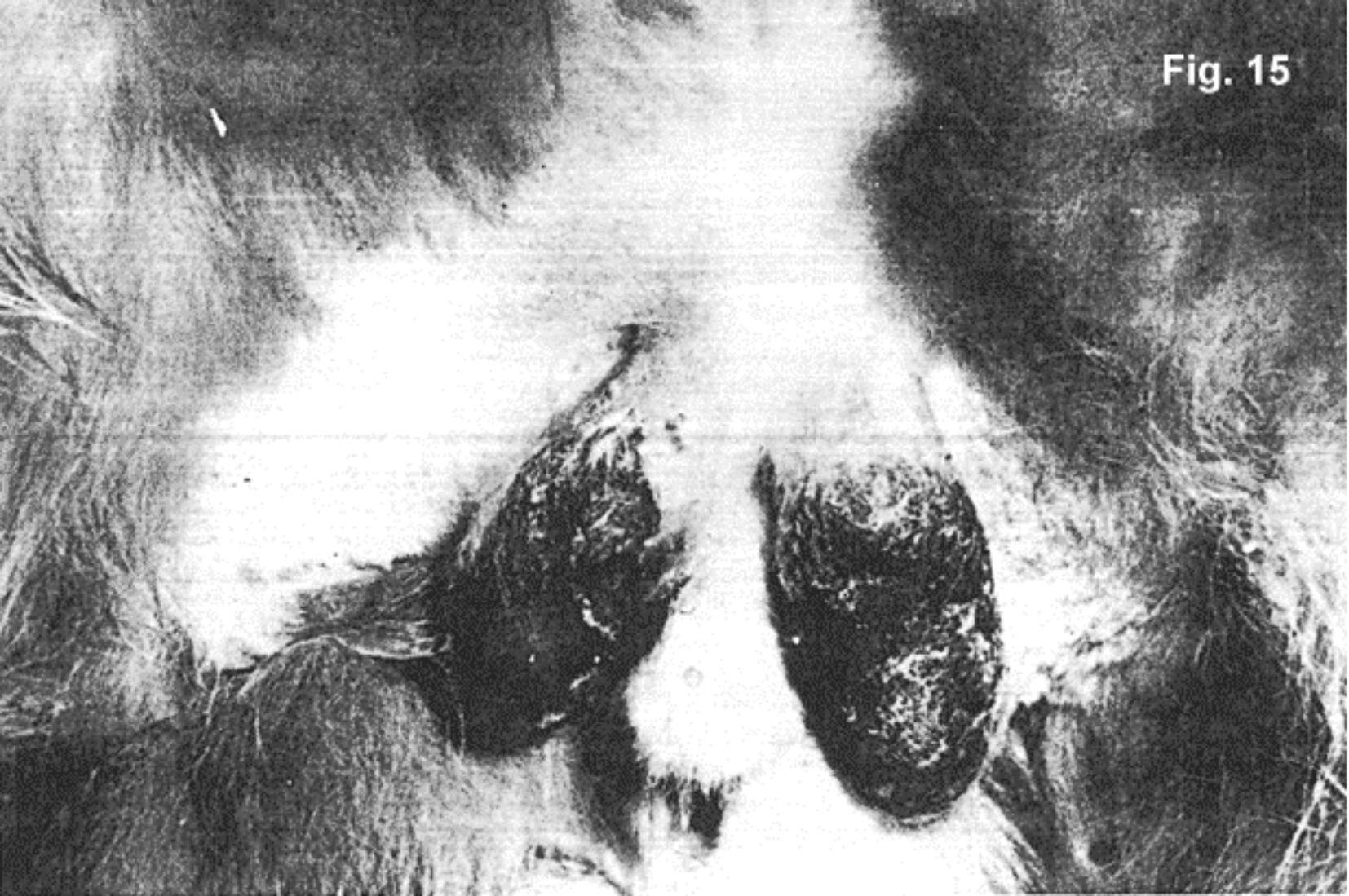

Fig. 13



Fig. 14

Fig. 15







a

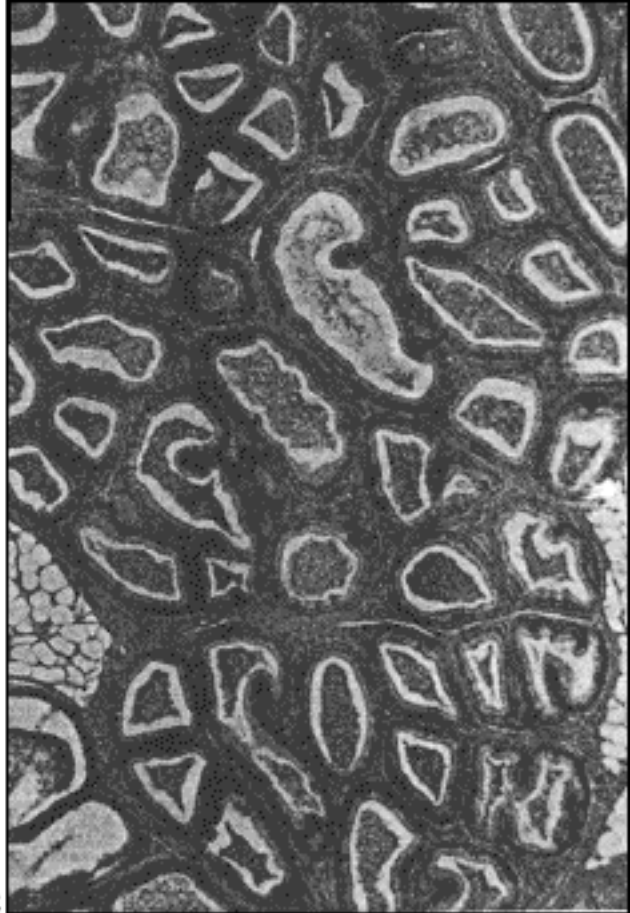

c

Fig. 16

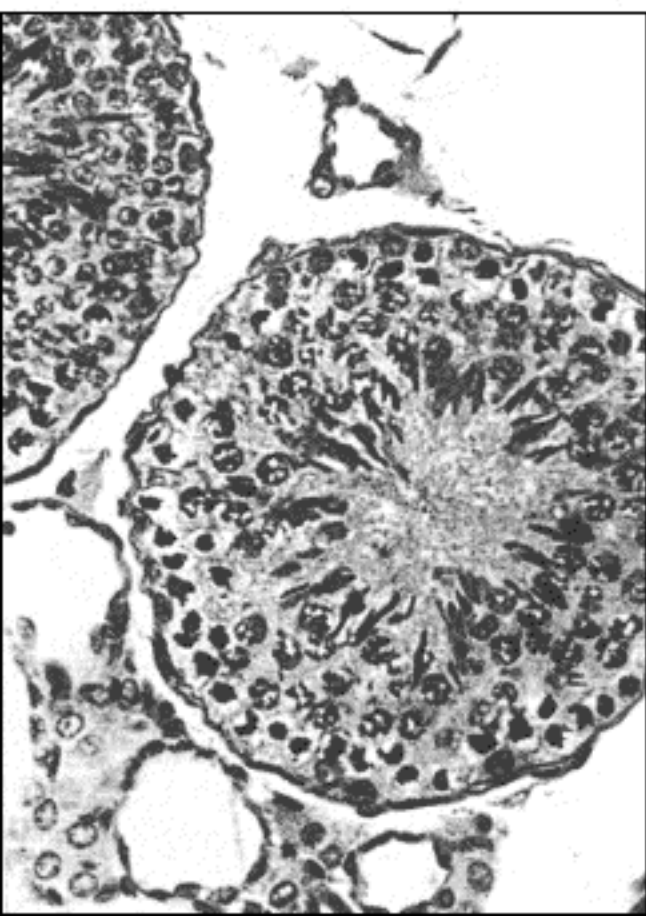

b

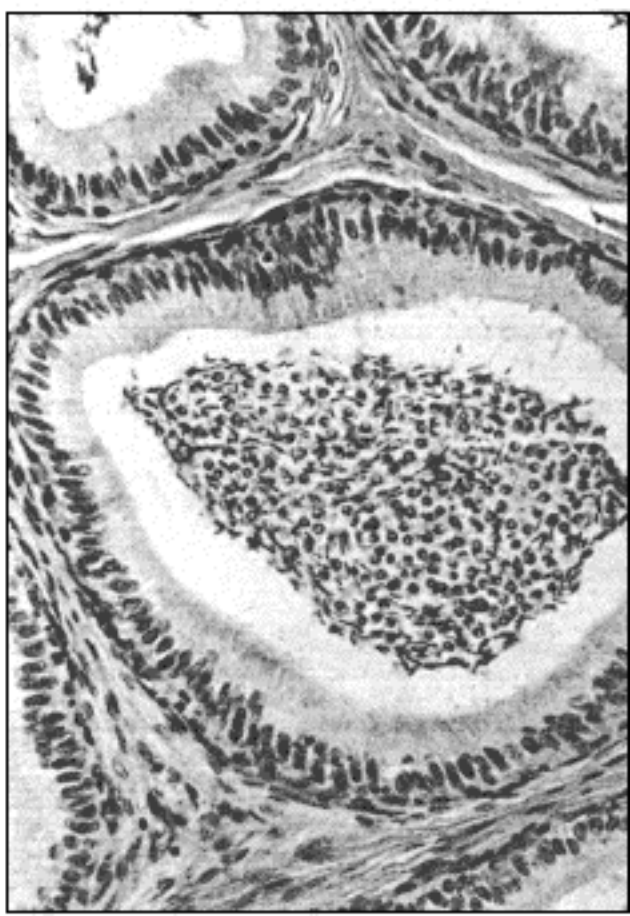

d



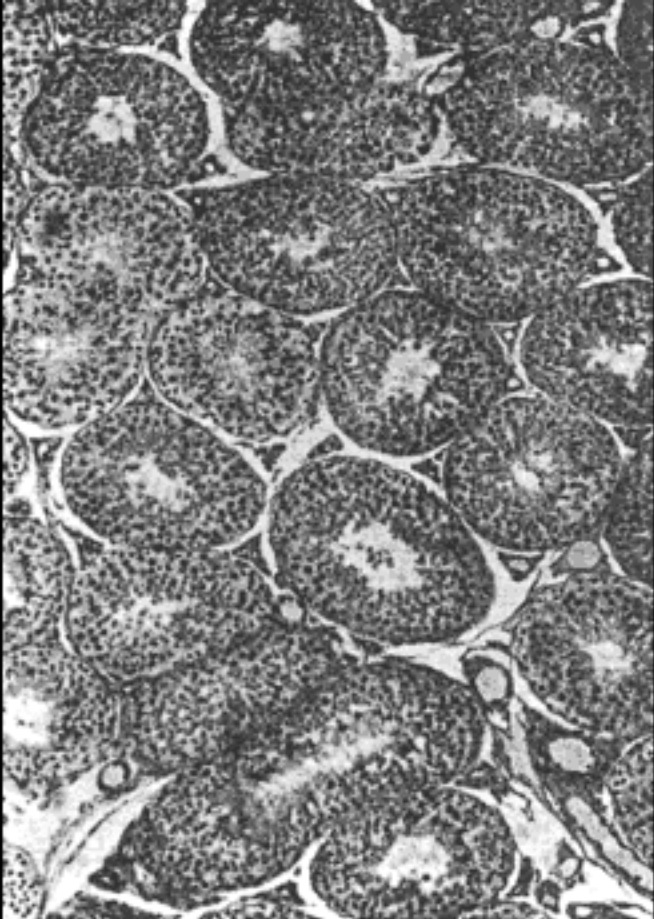

a

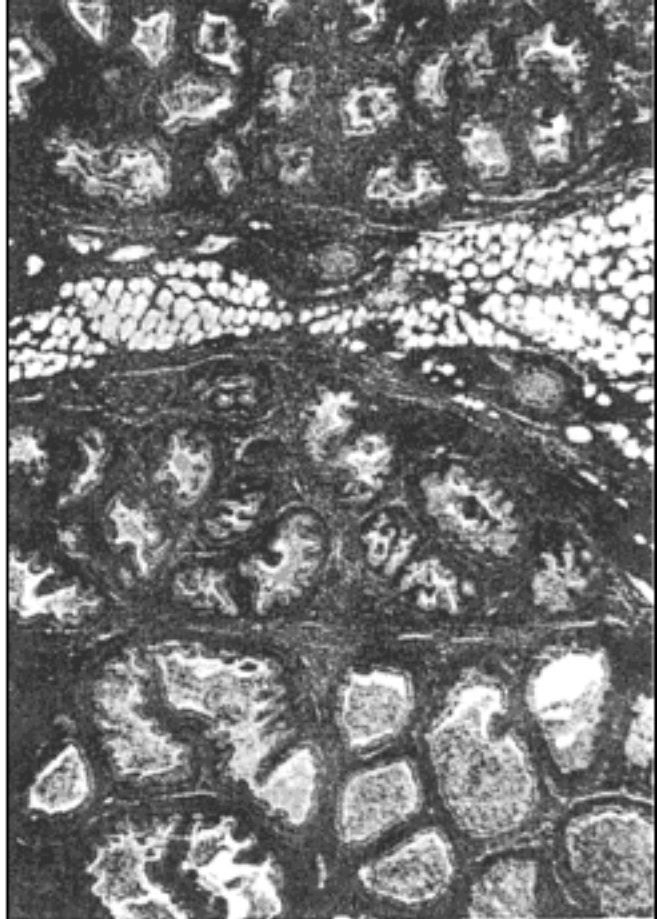

b

Fig. 17

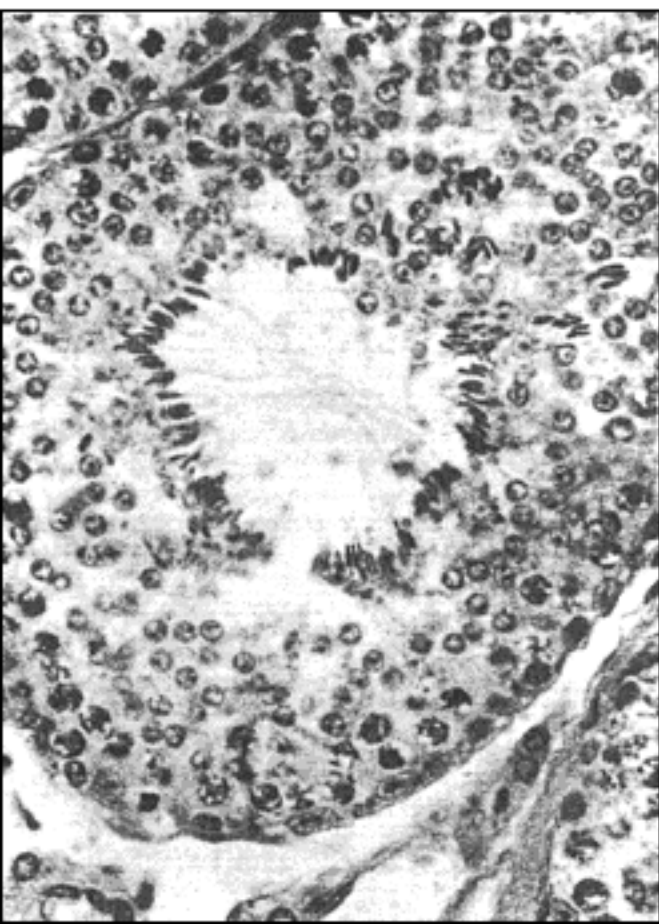

c



d



a

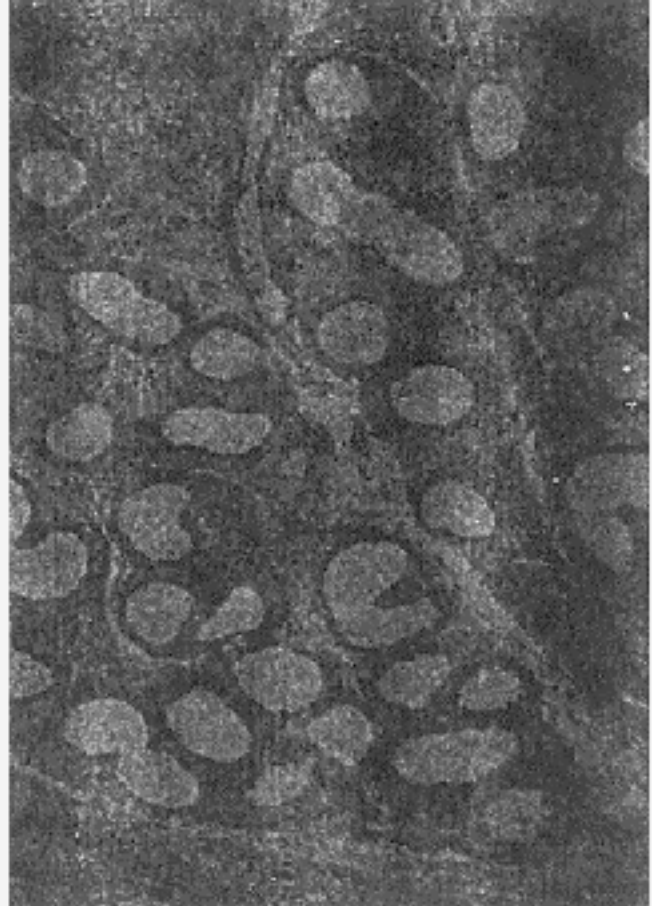

c

Fig. 18



b

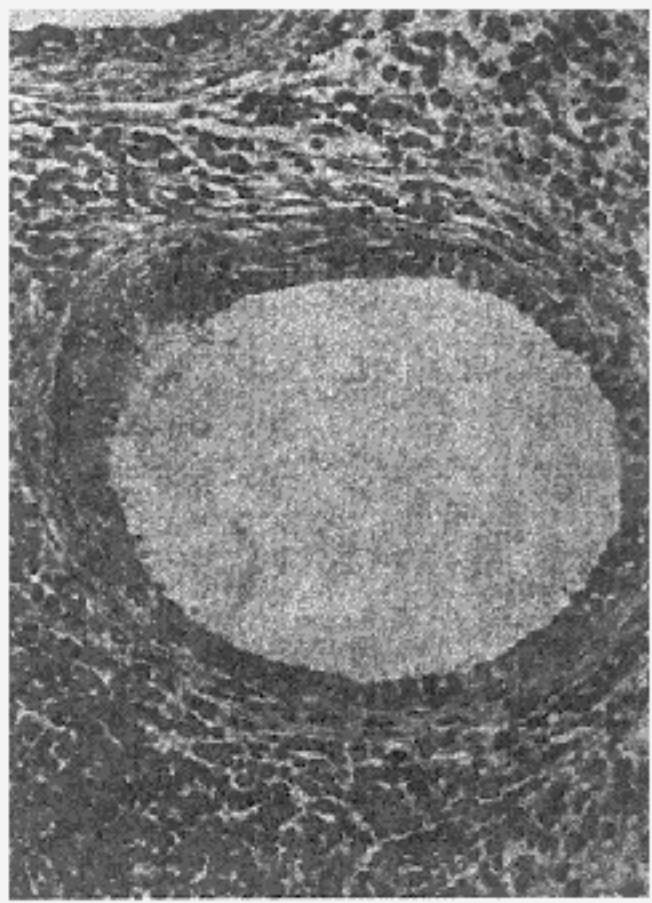

d



a

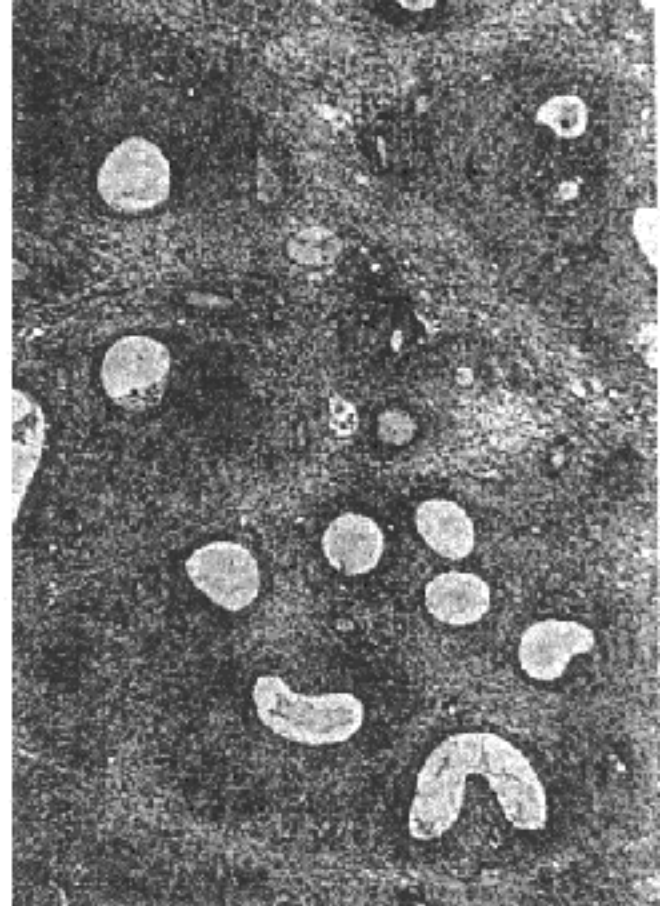

c

Fig. 19

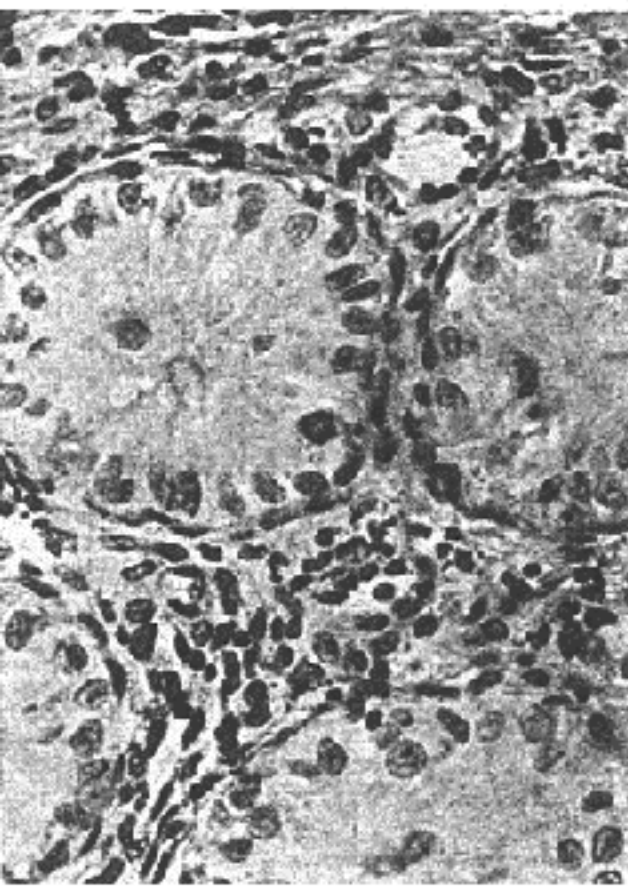

b

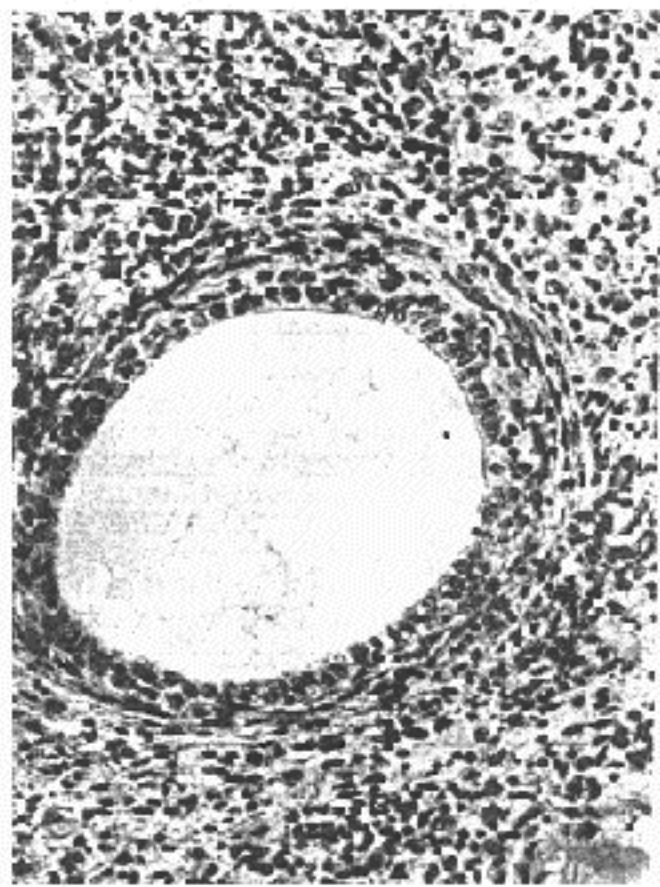

d

Fig. 20

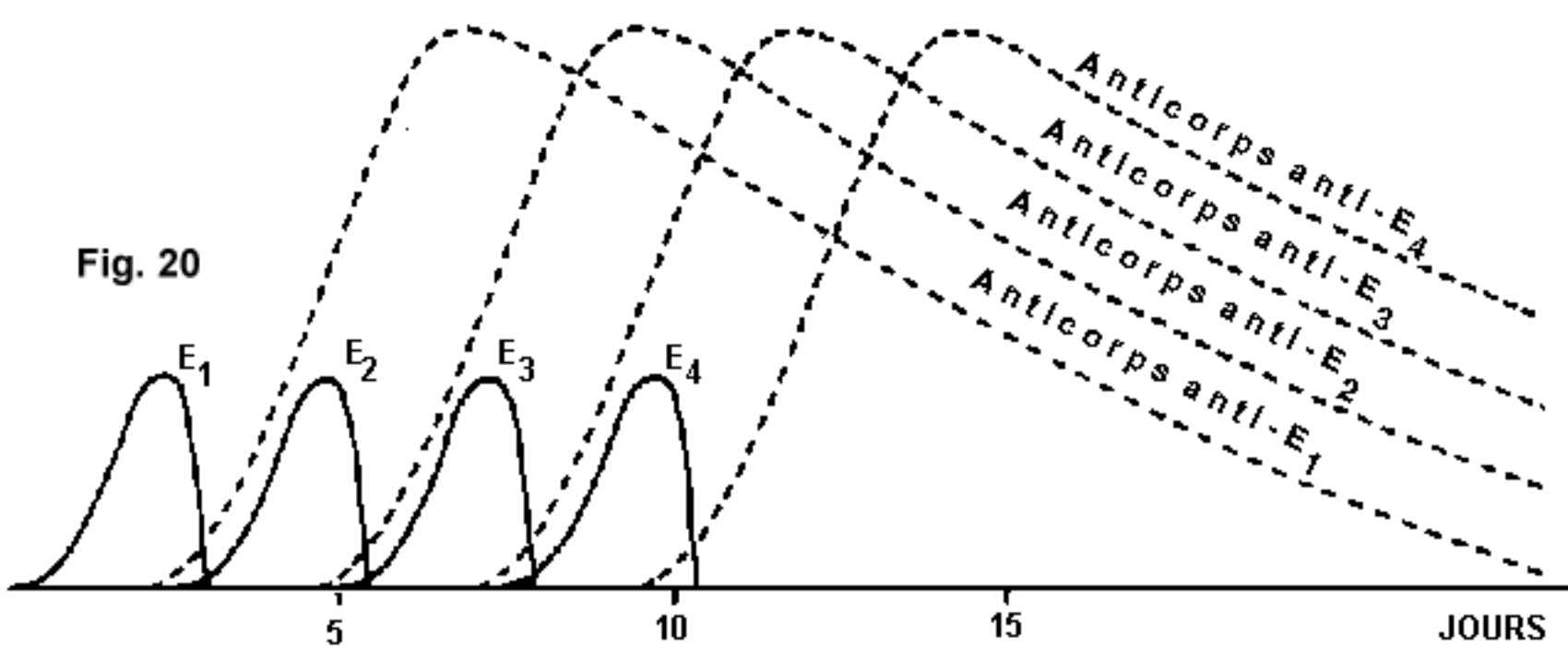

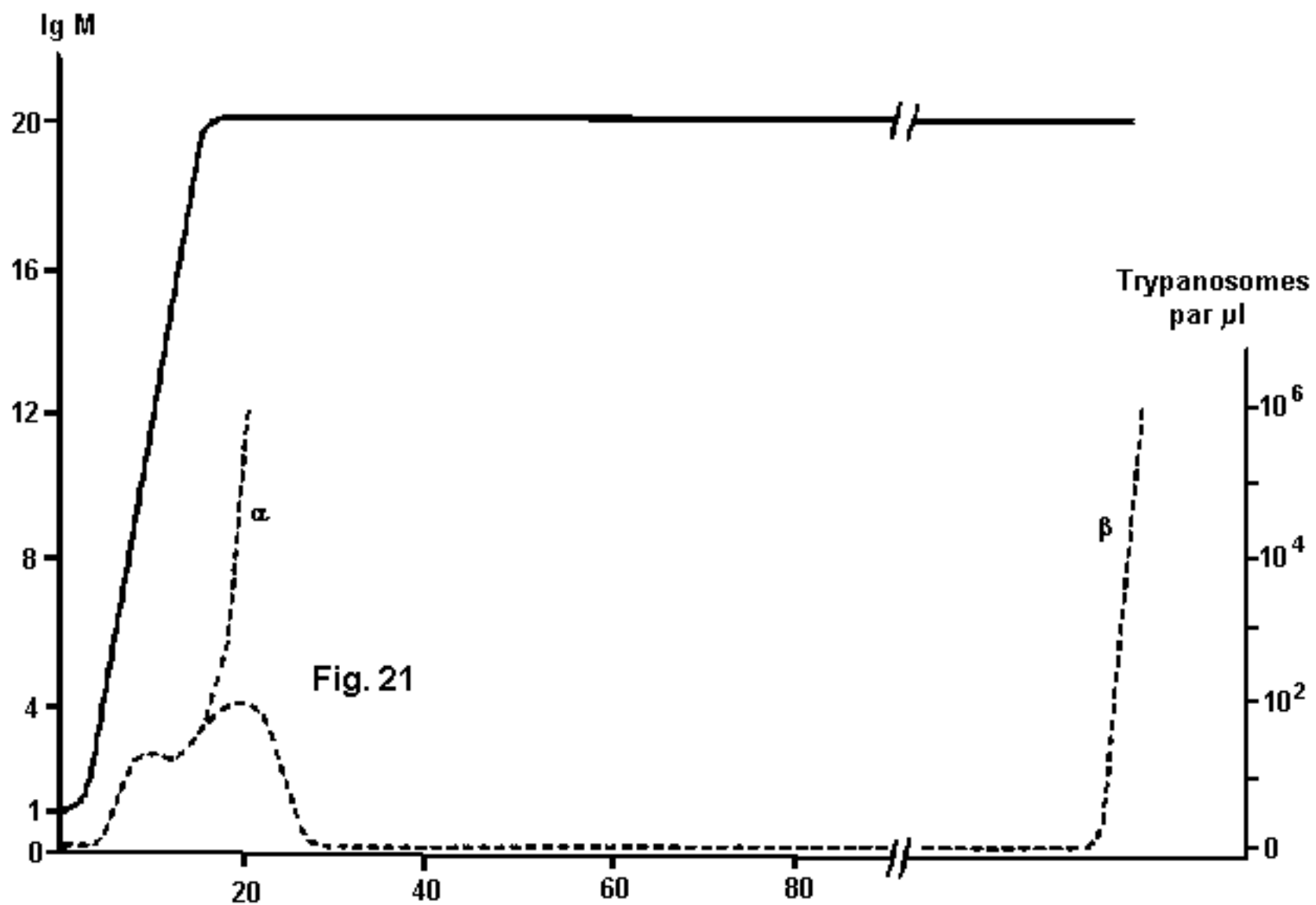

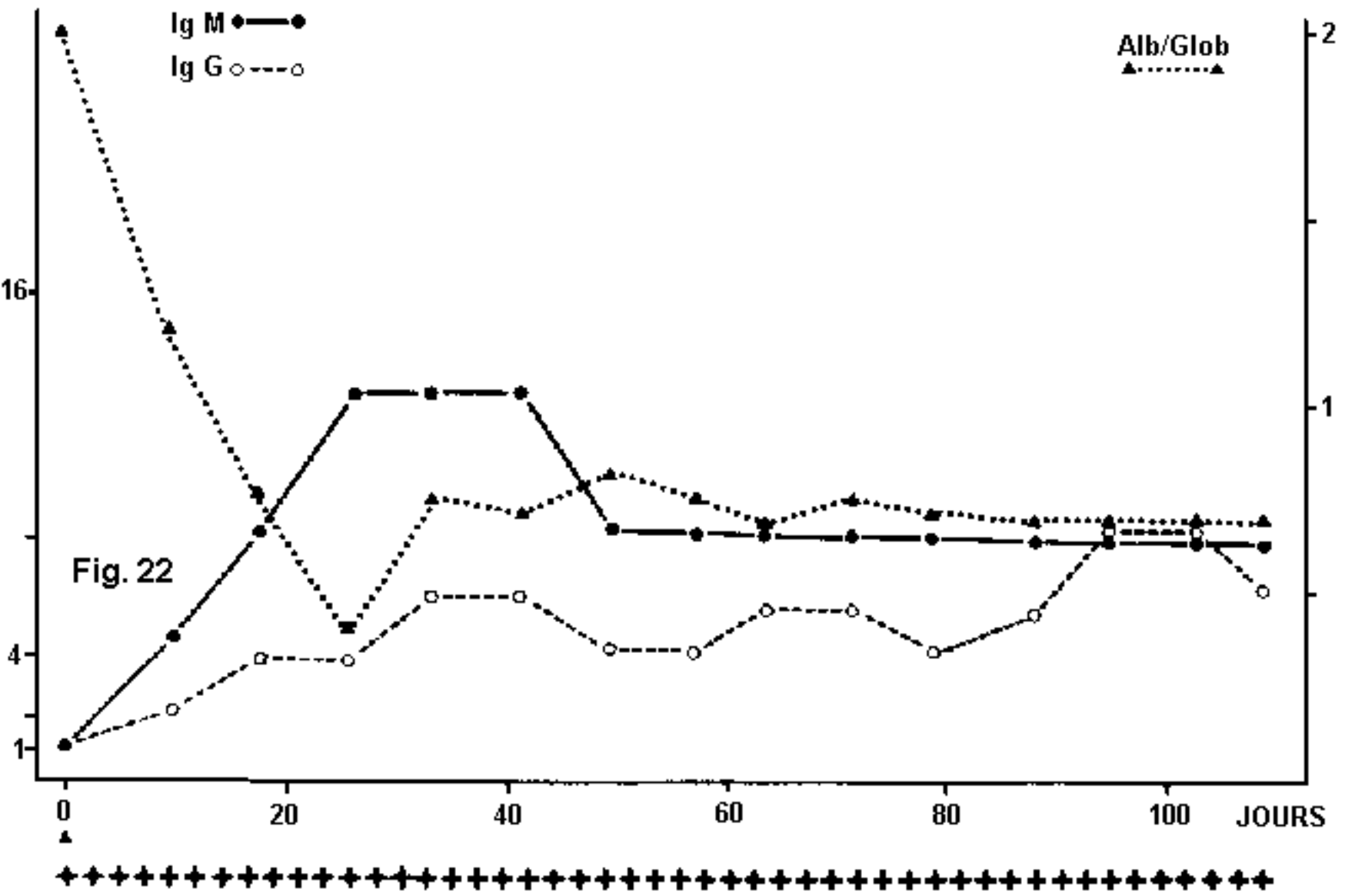



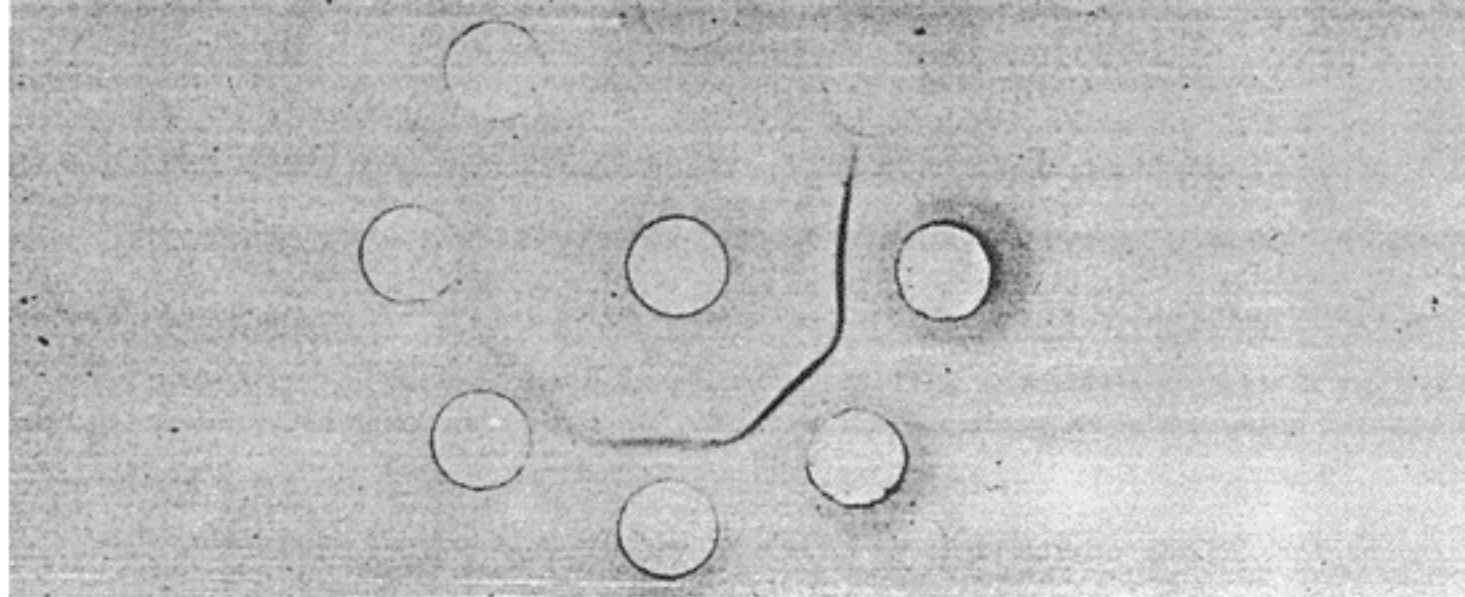

a

Fig. 23

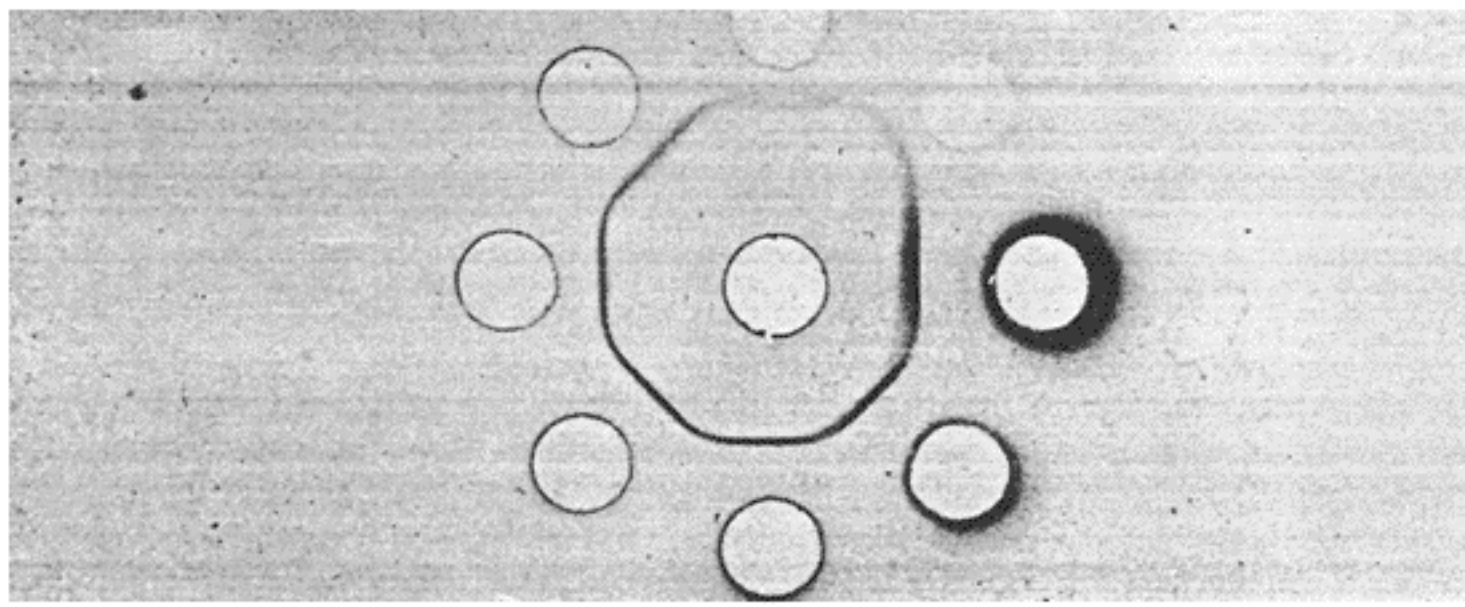

b

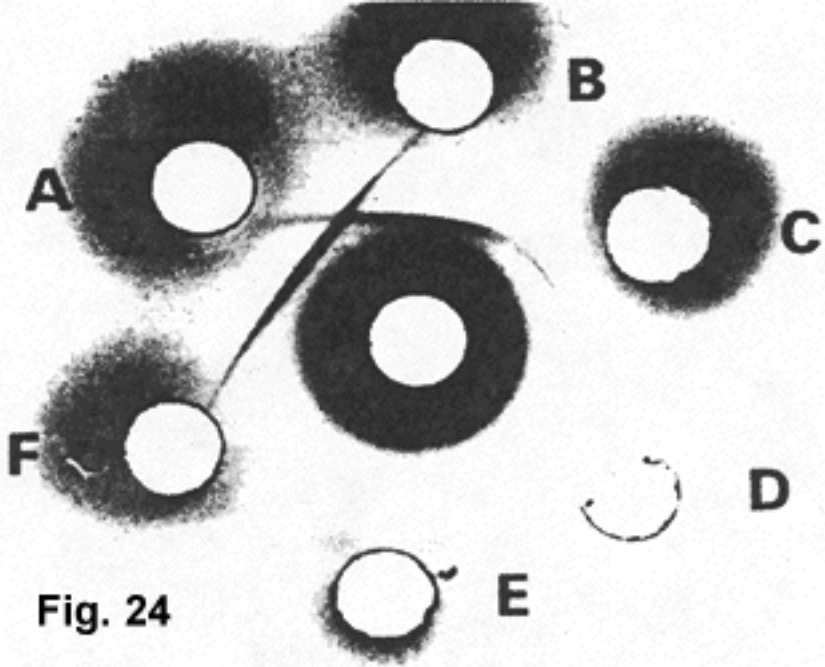

Fig. 24

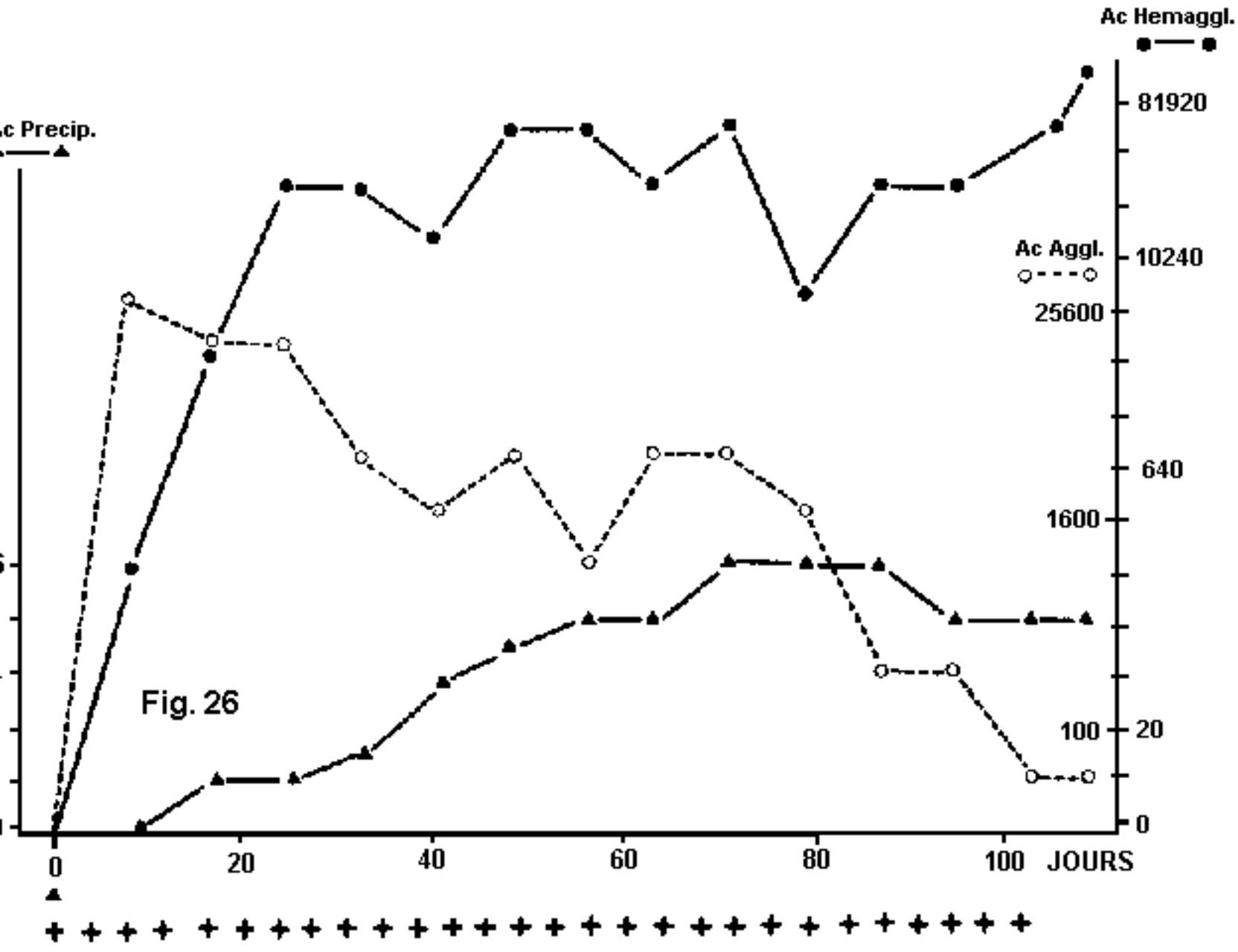

Fig. 25

+



-



Trypanosomes  
par  $\mu$ l

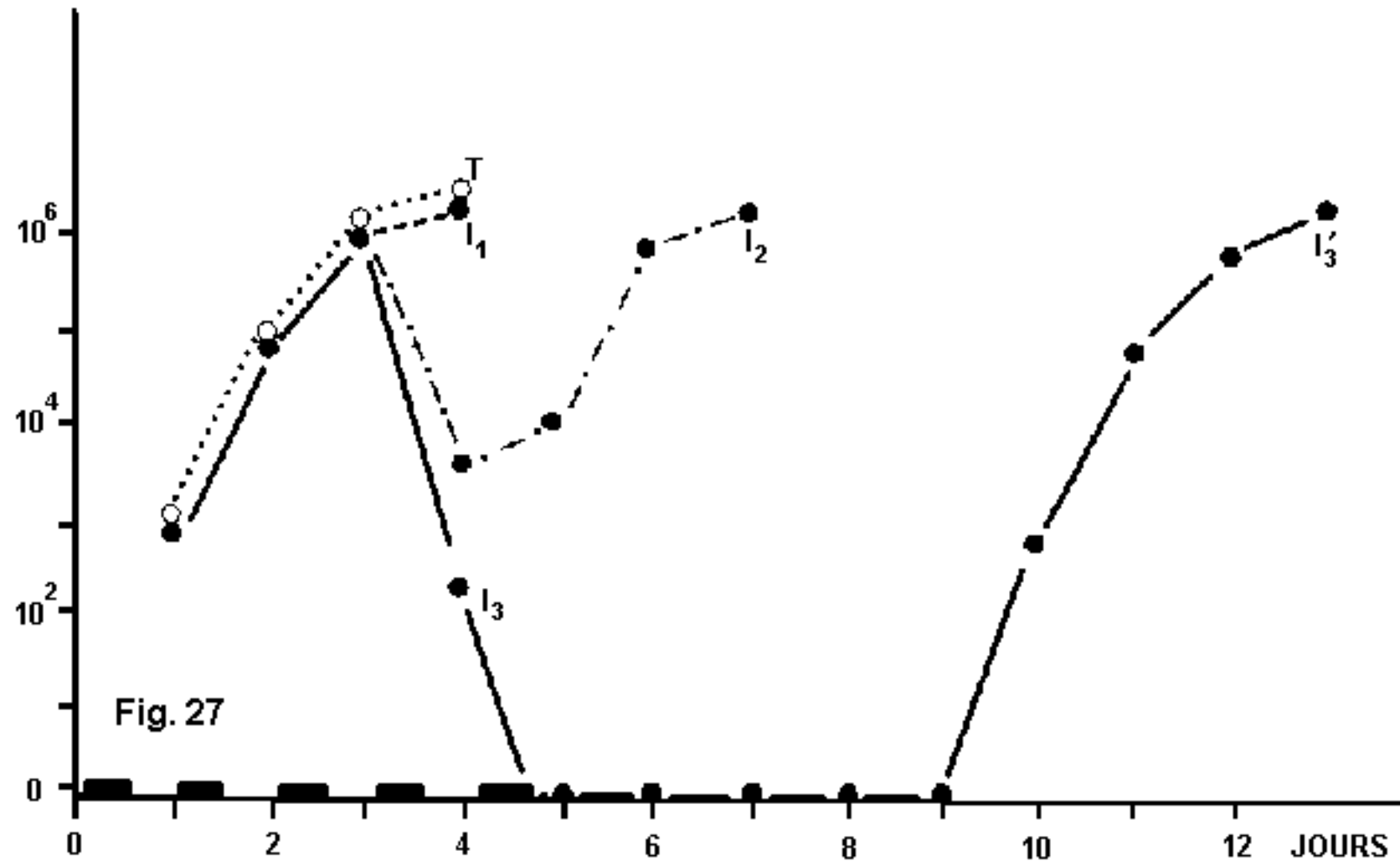

Trypanosomes  
par  $\mu$ l

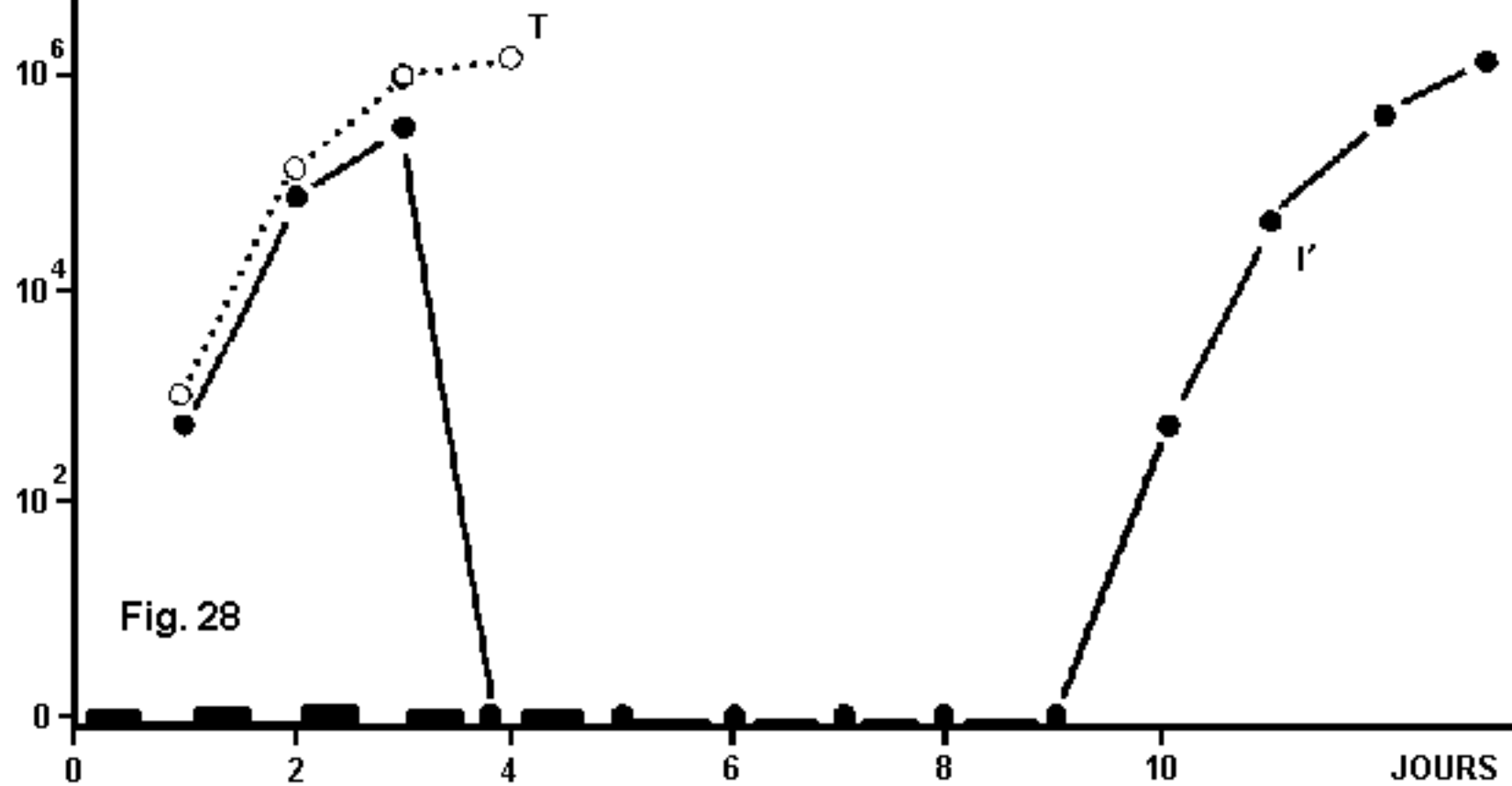
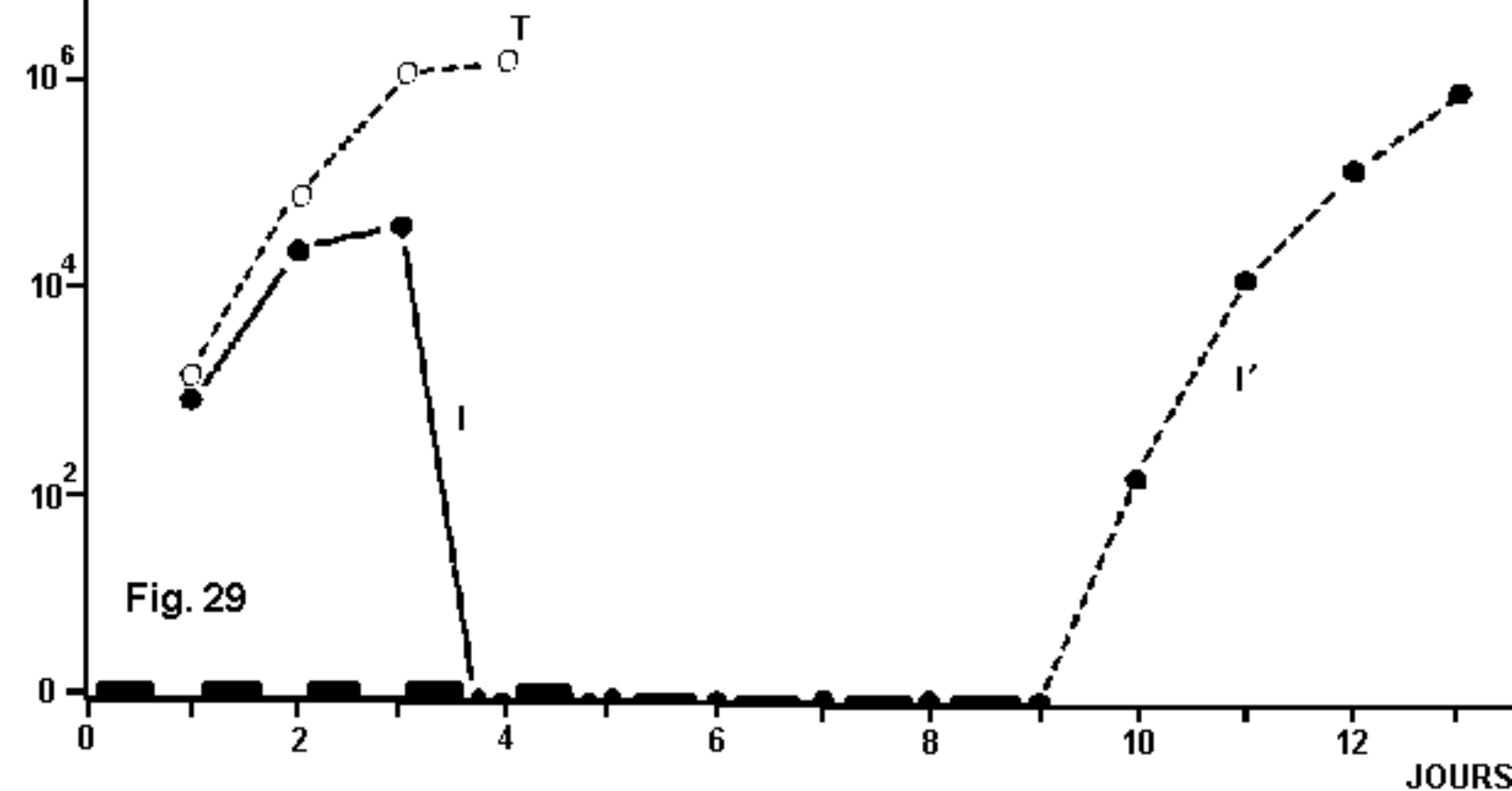

Fig. 28

Trypanosomes  
par  $\mu$ l



Trypanosomes  
par  $\mu$ l

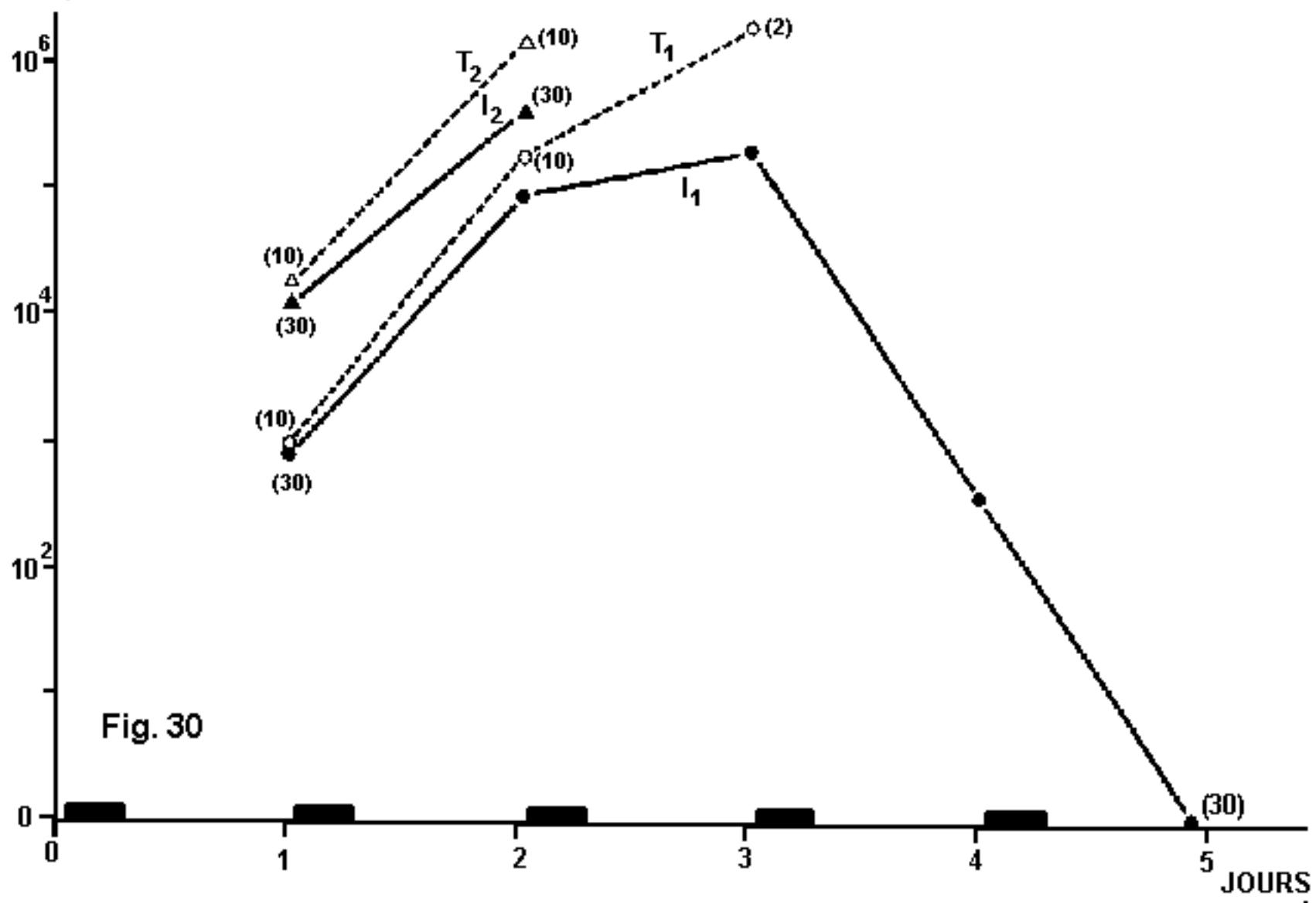

Fig. 30



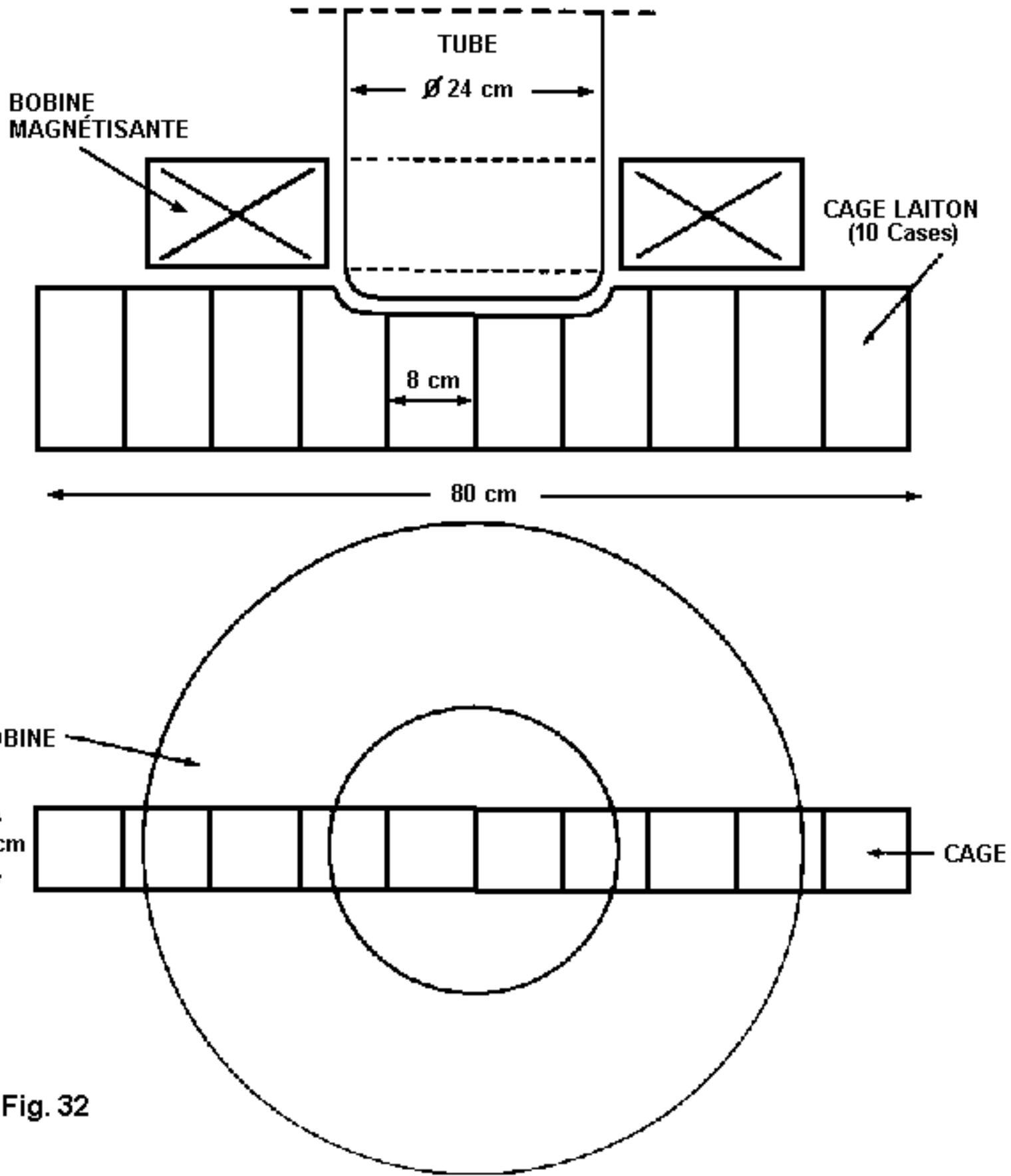

Fig. 32



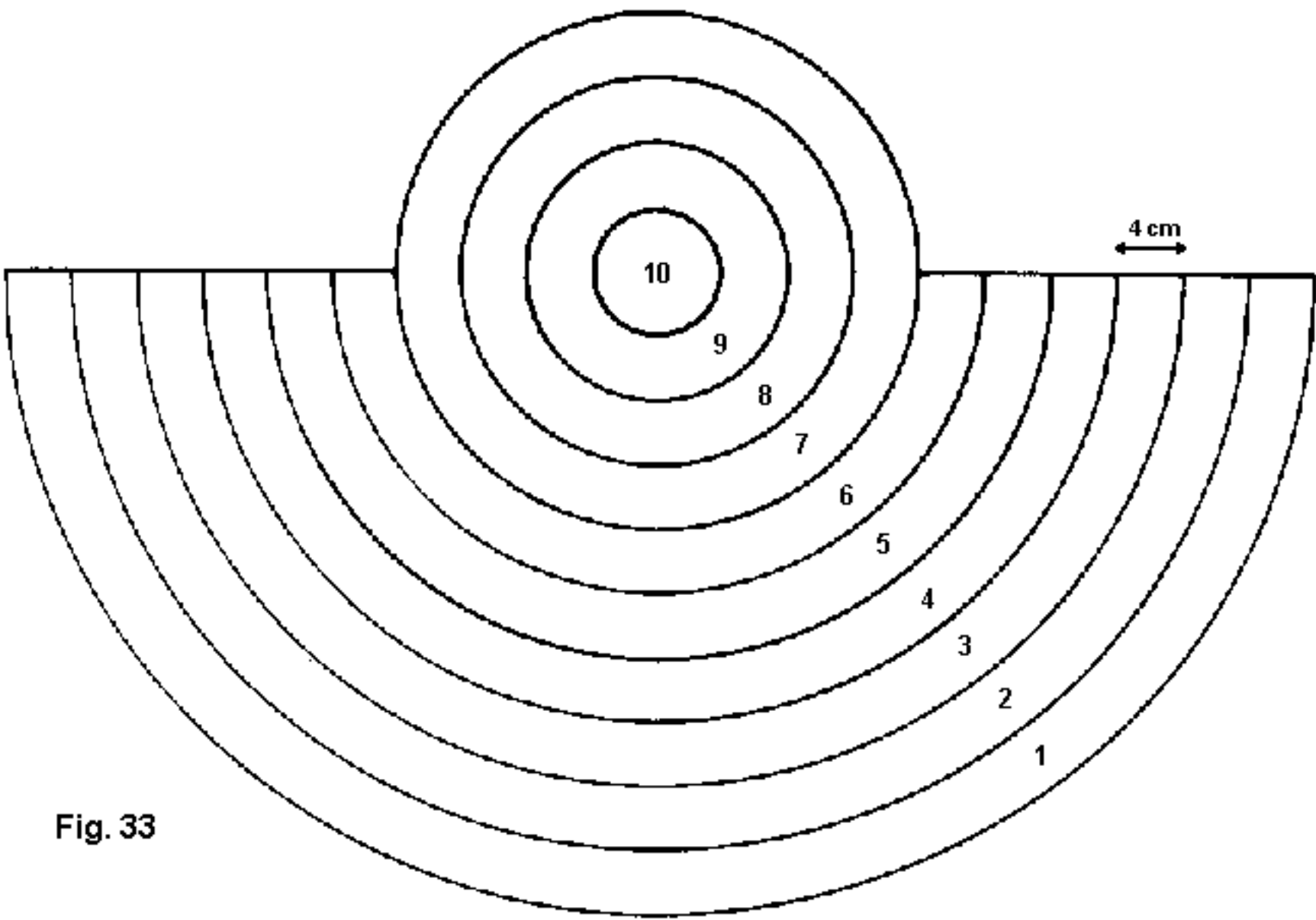
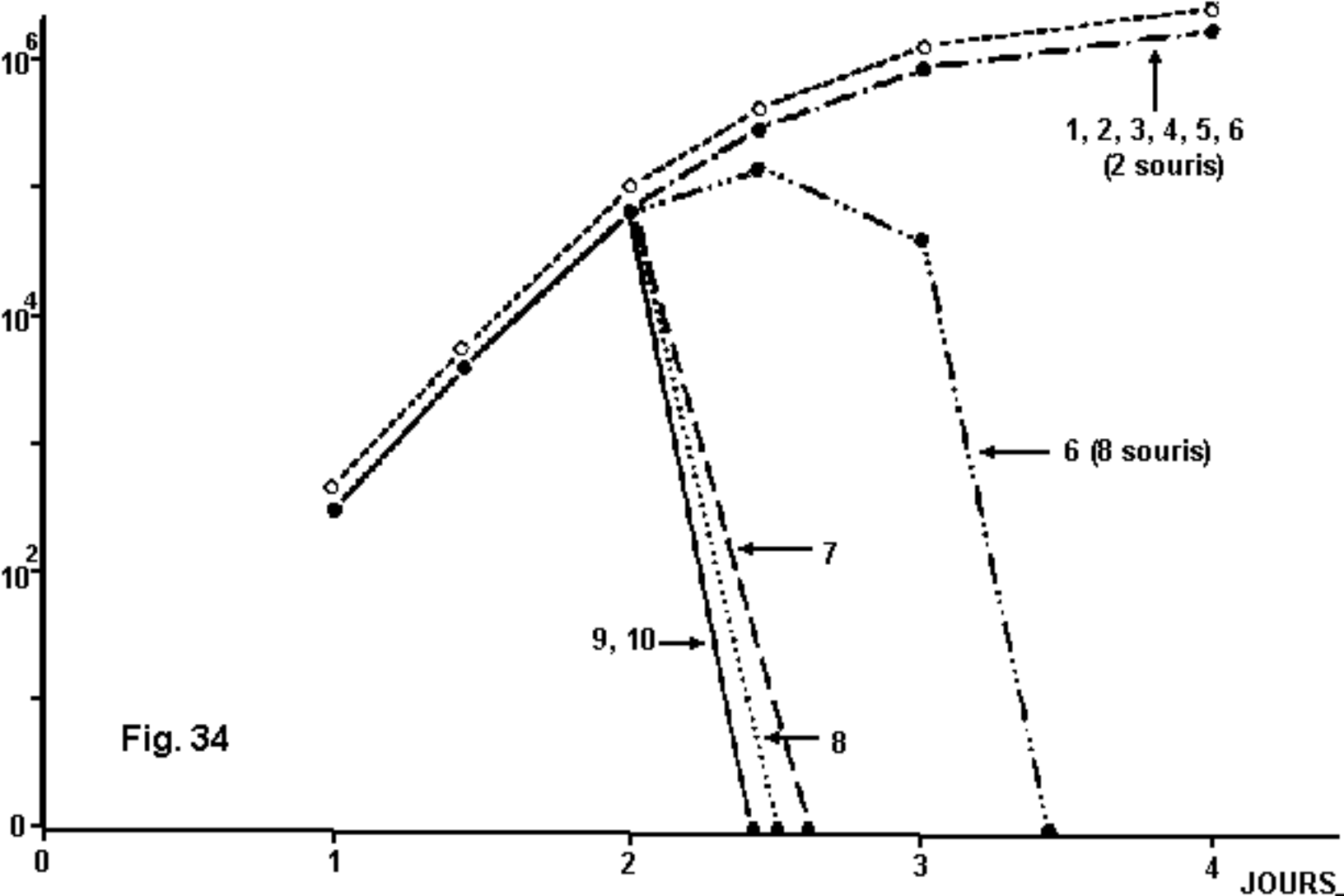
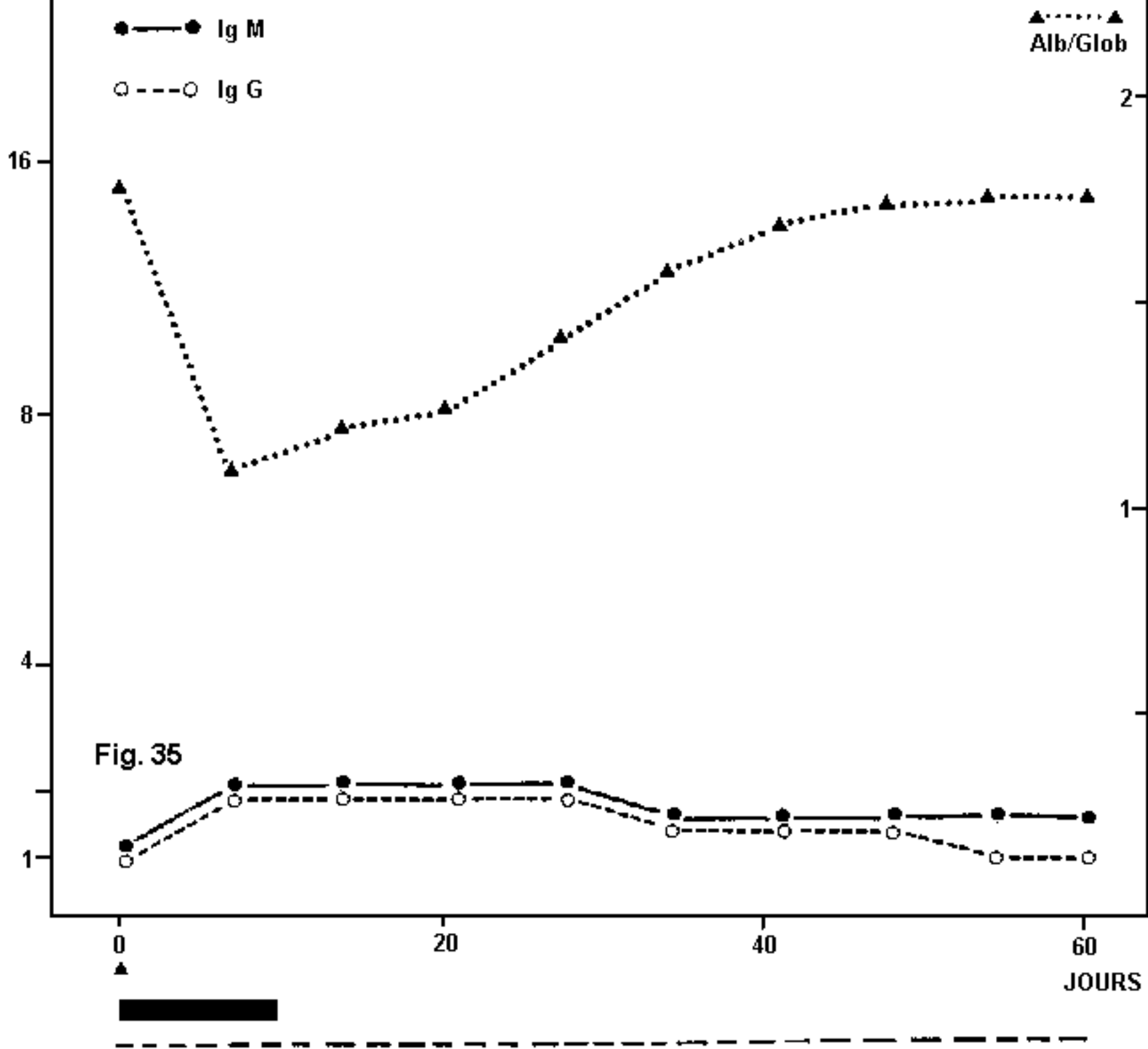
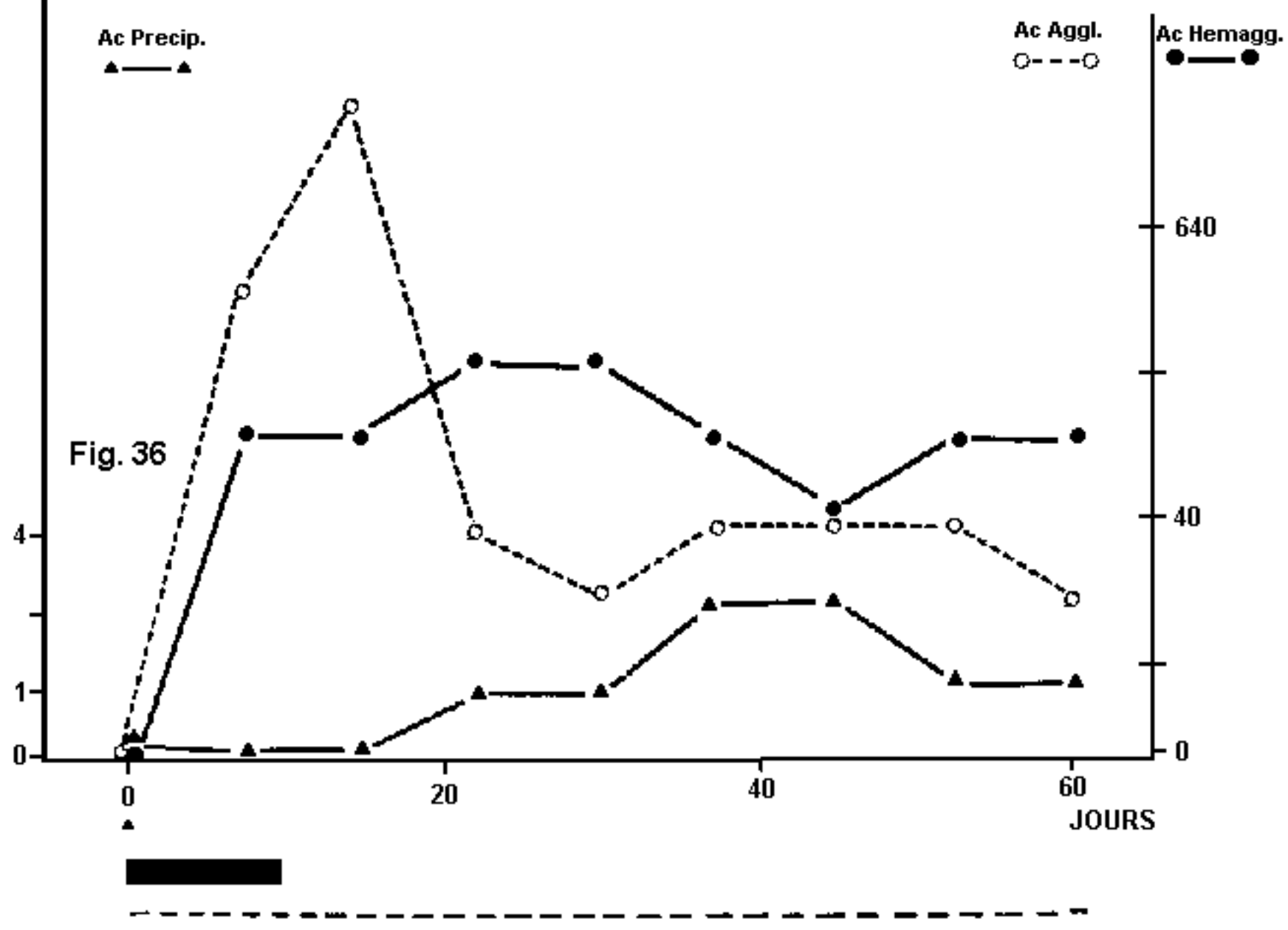

Fig. 33

Trypanosomes  
par  $\mu$ l







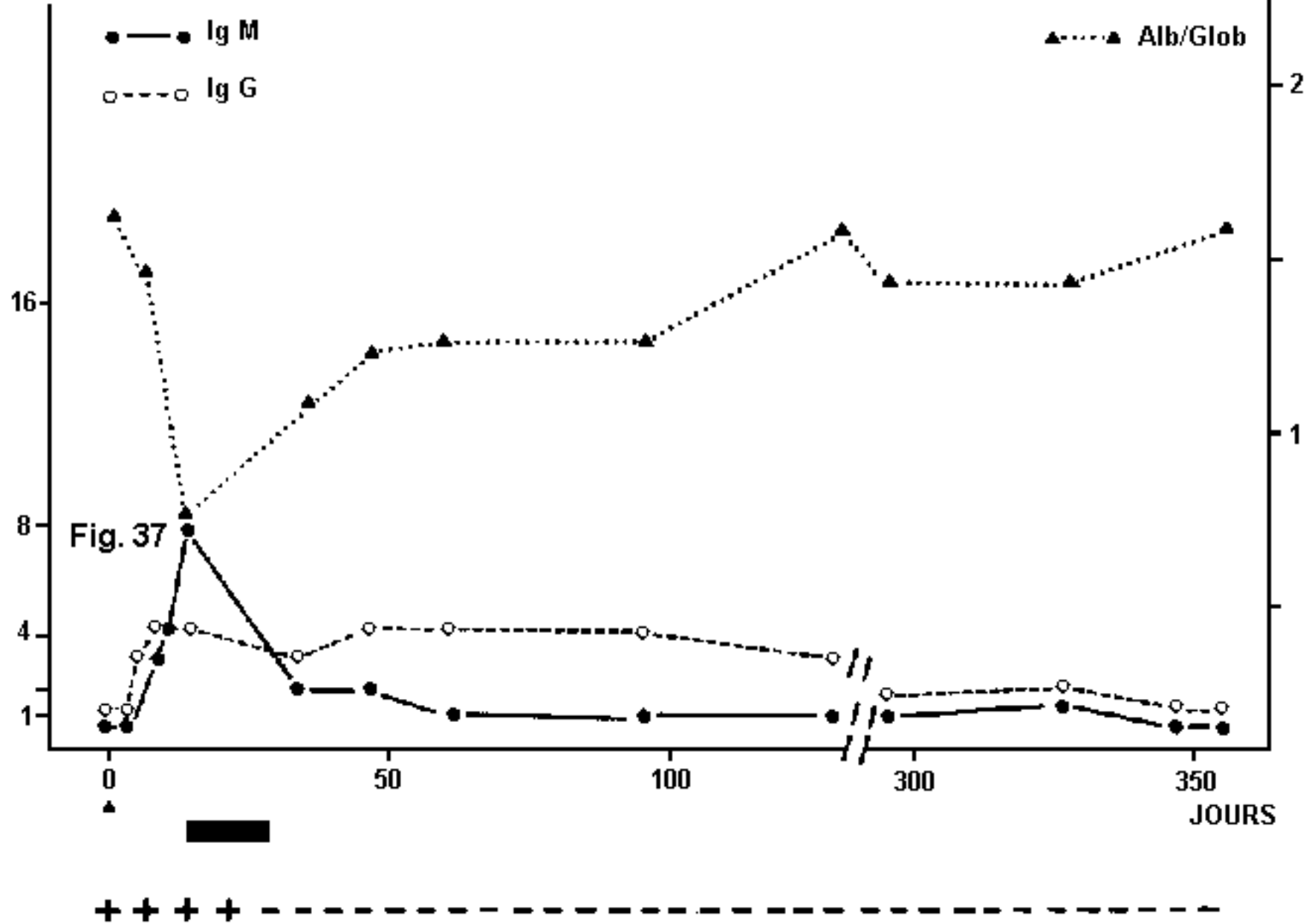

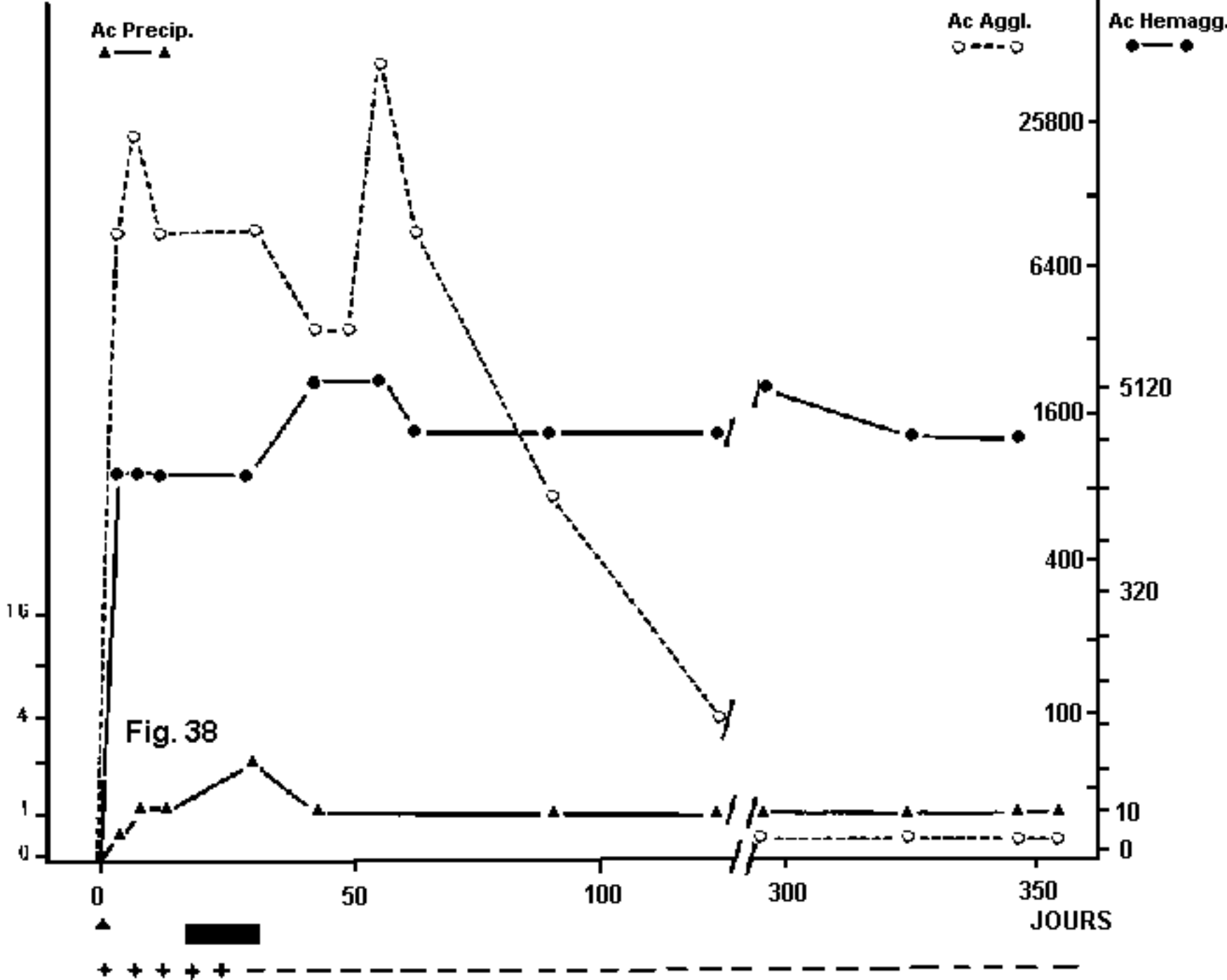

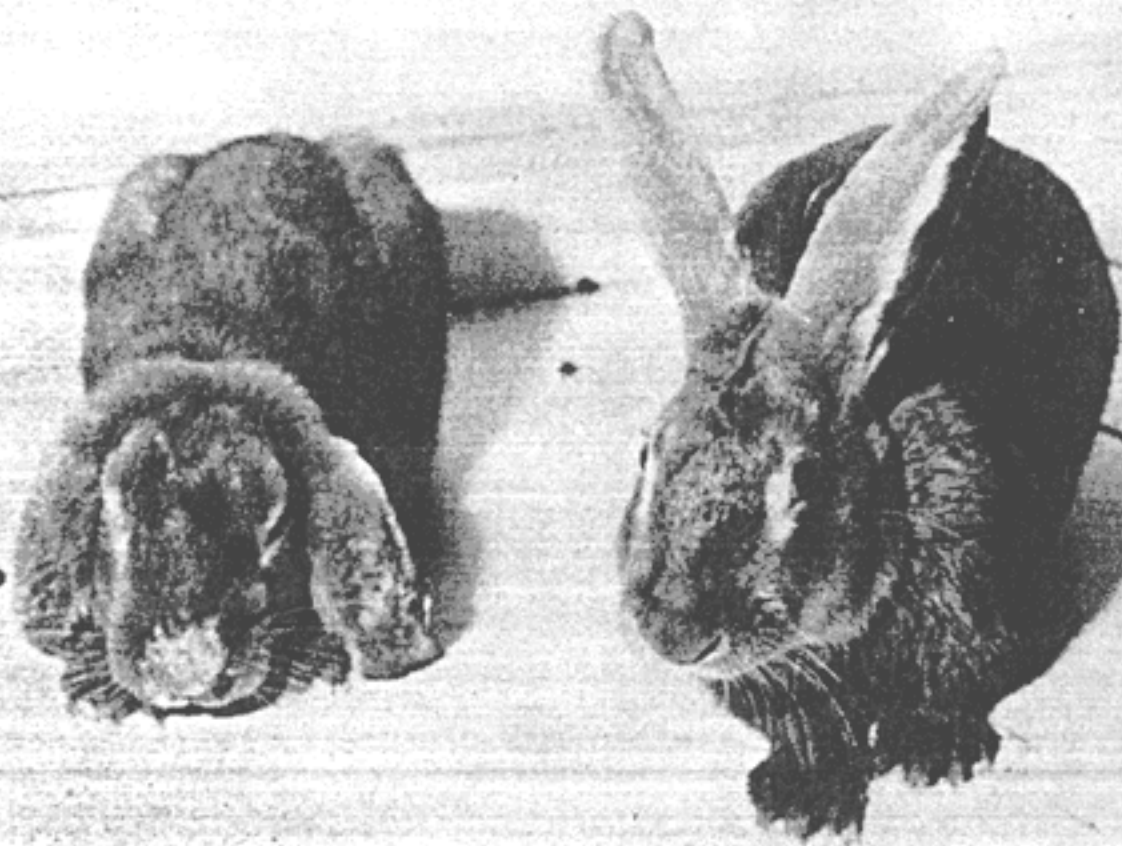
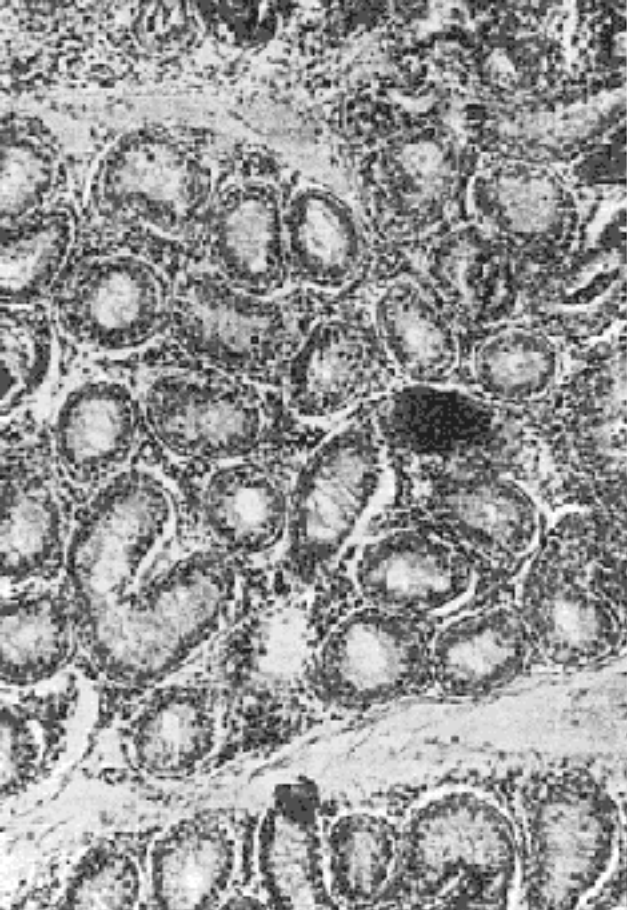

Fig. 39



a c

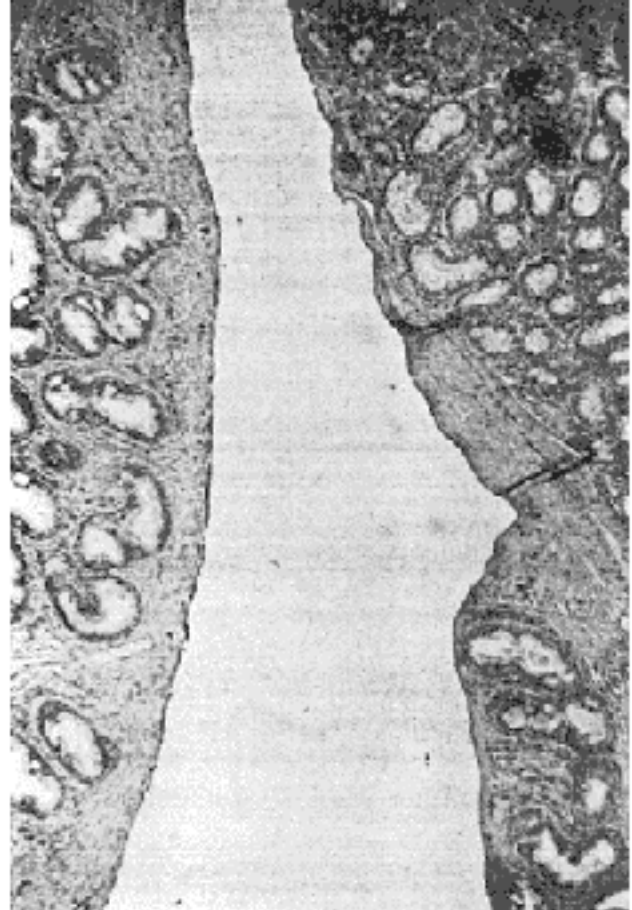
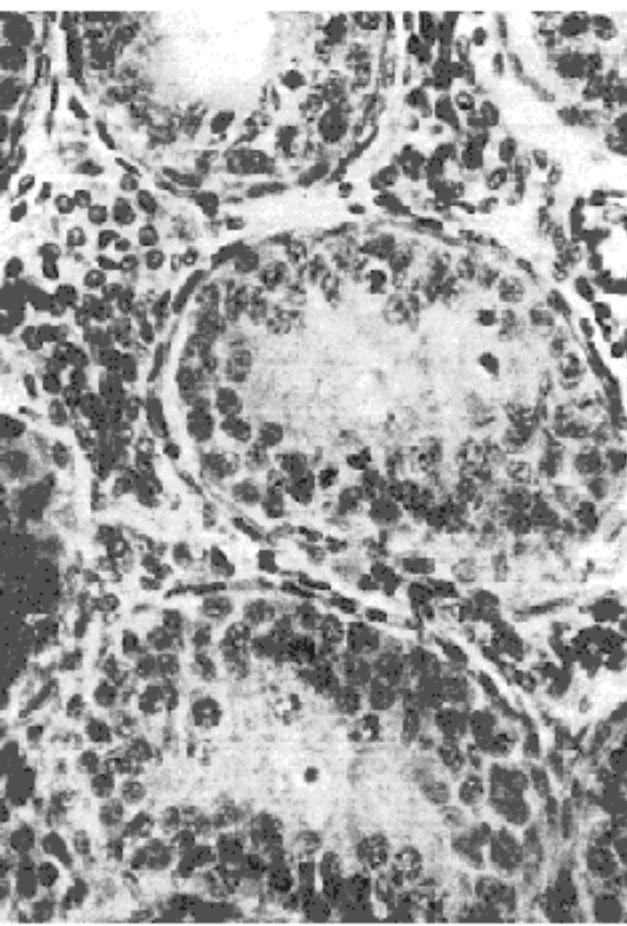
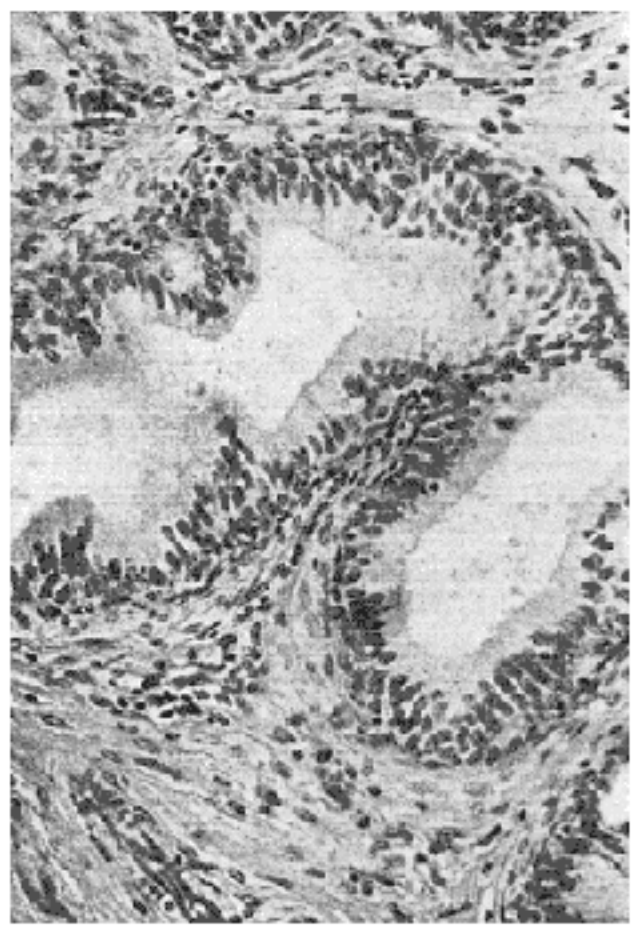

Fig. 40



b d





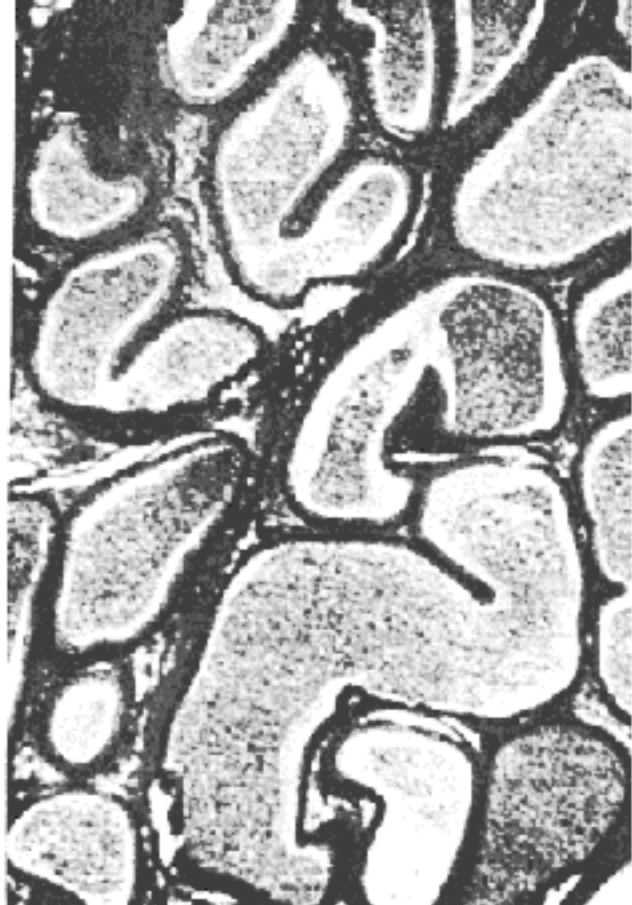

c a



Fig. 41

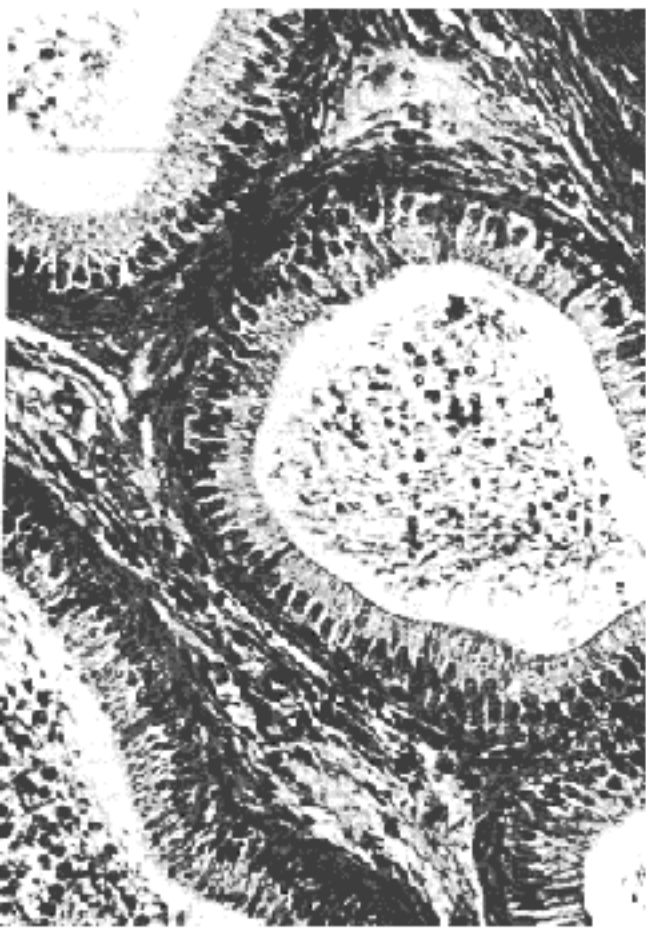

d b

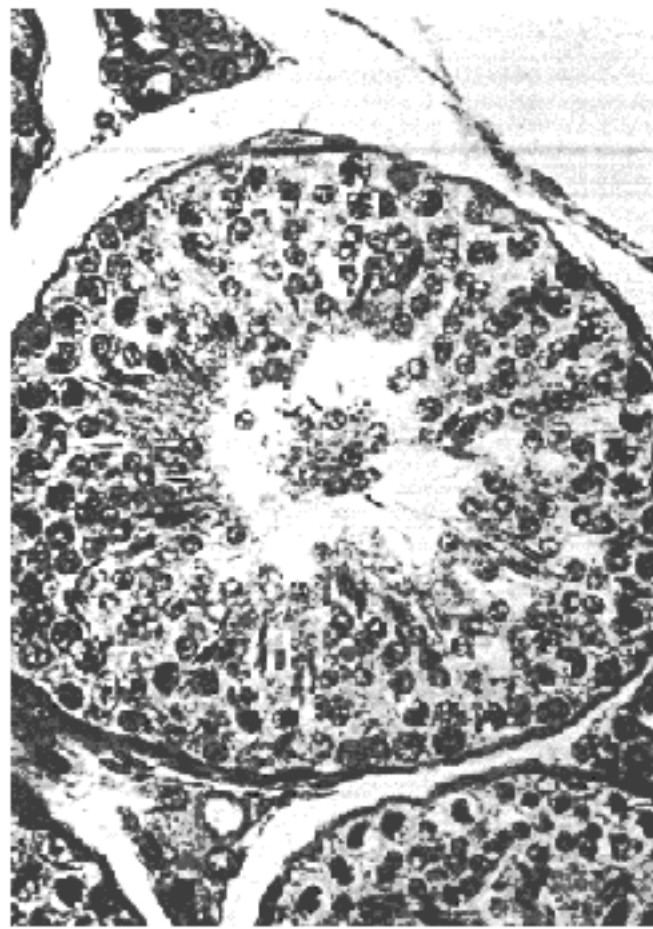

## TEMPERATURES

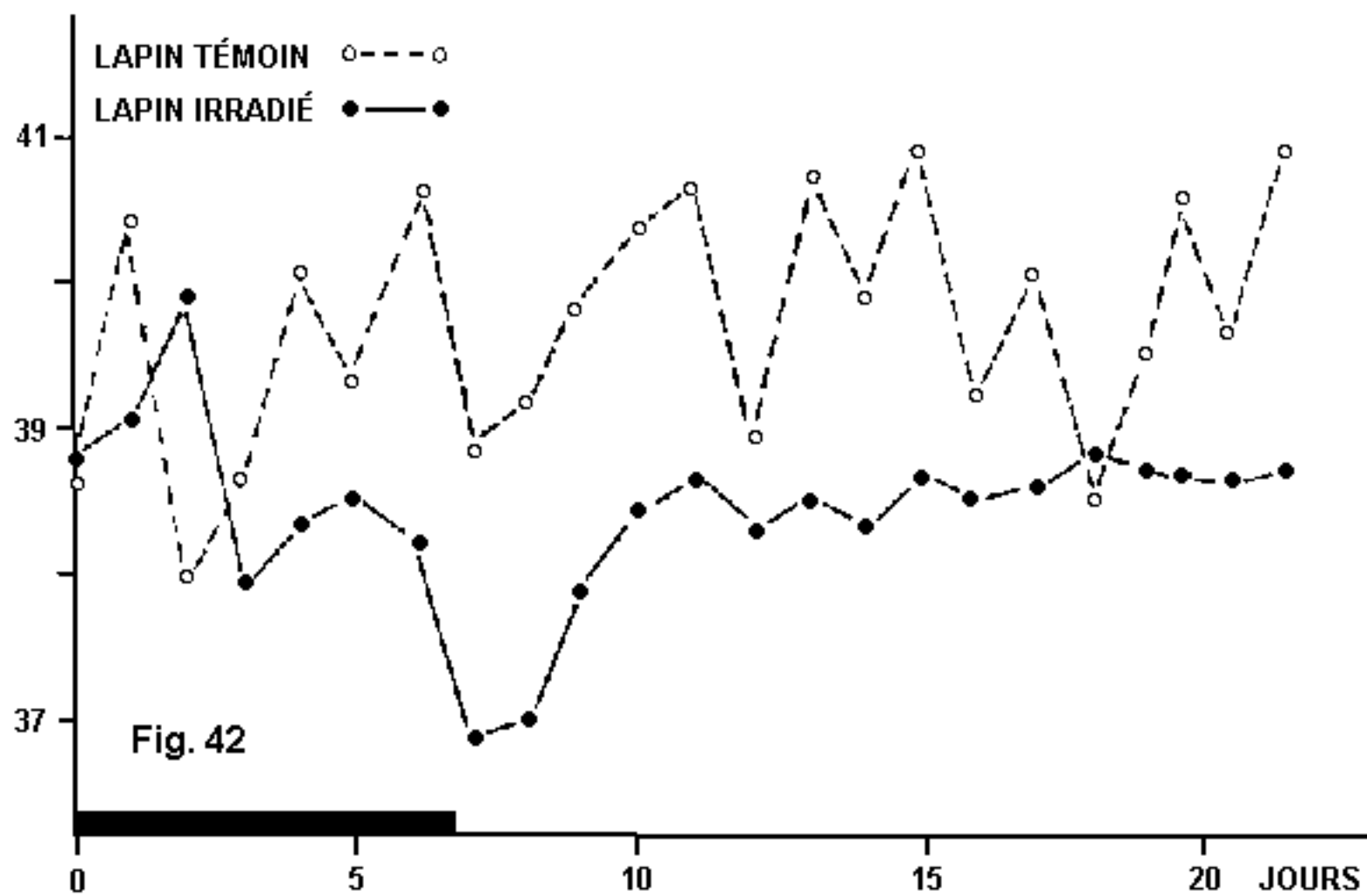
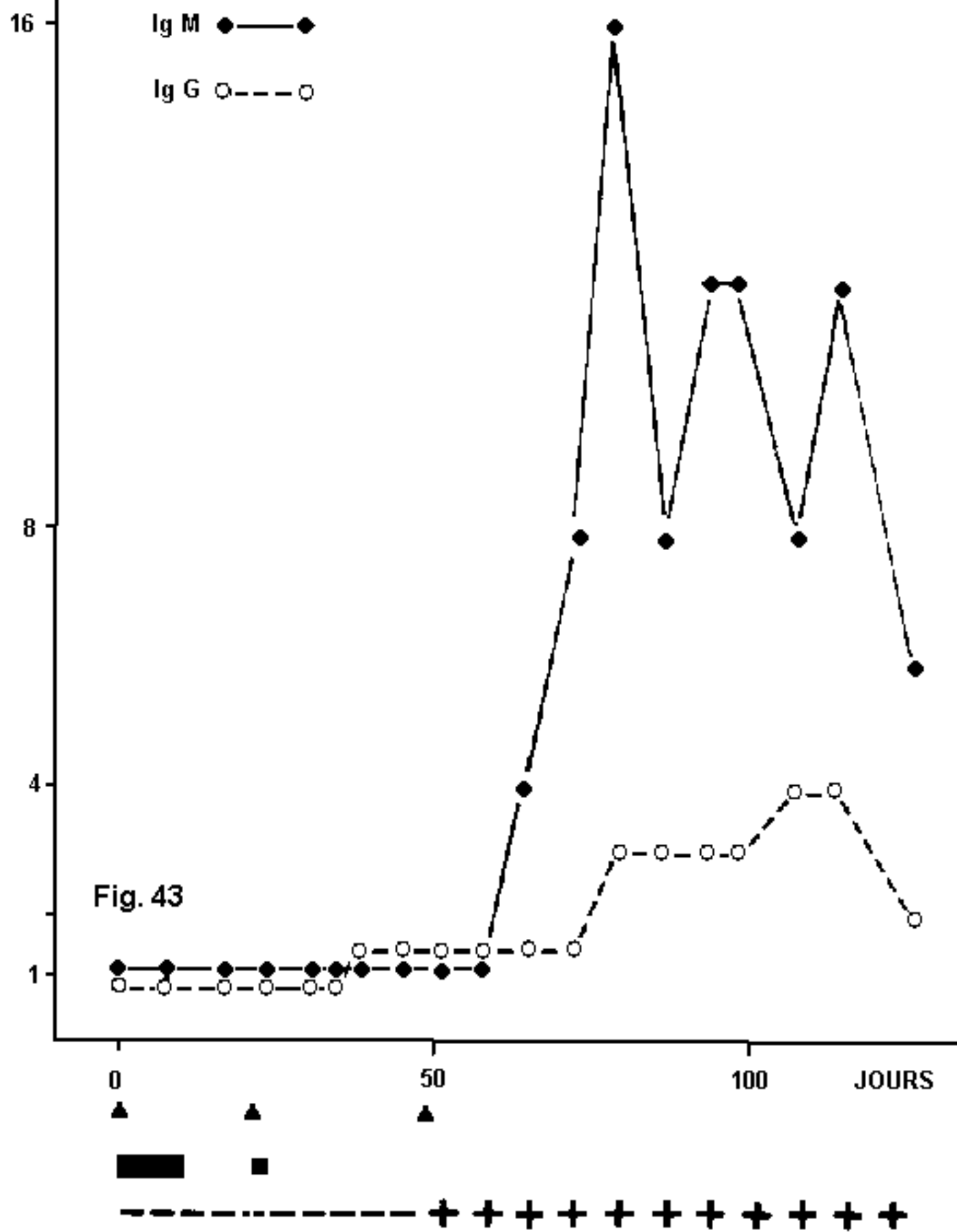
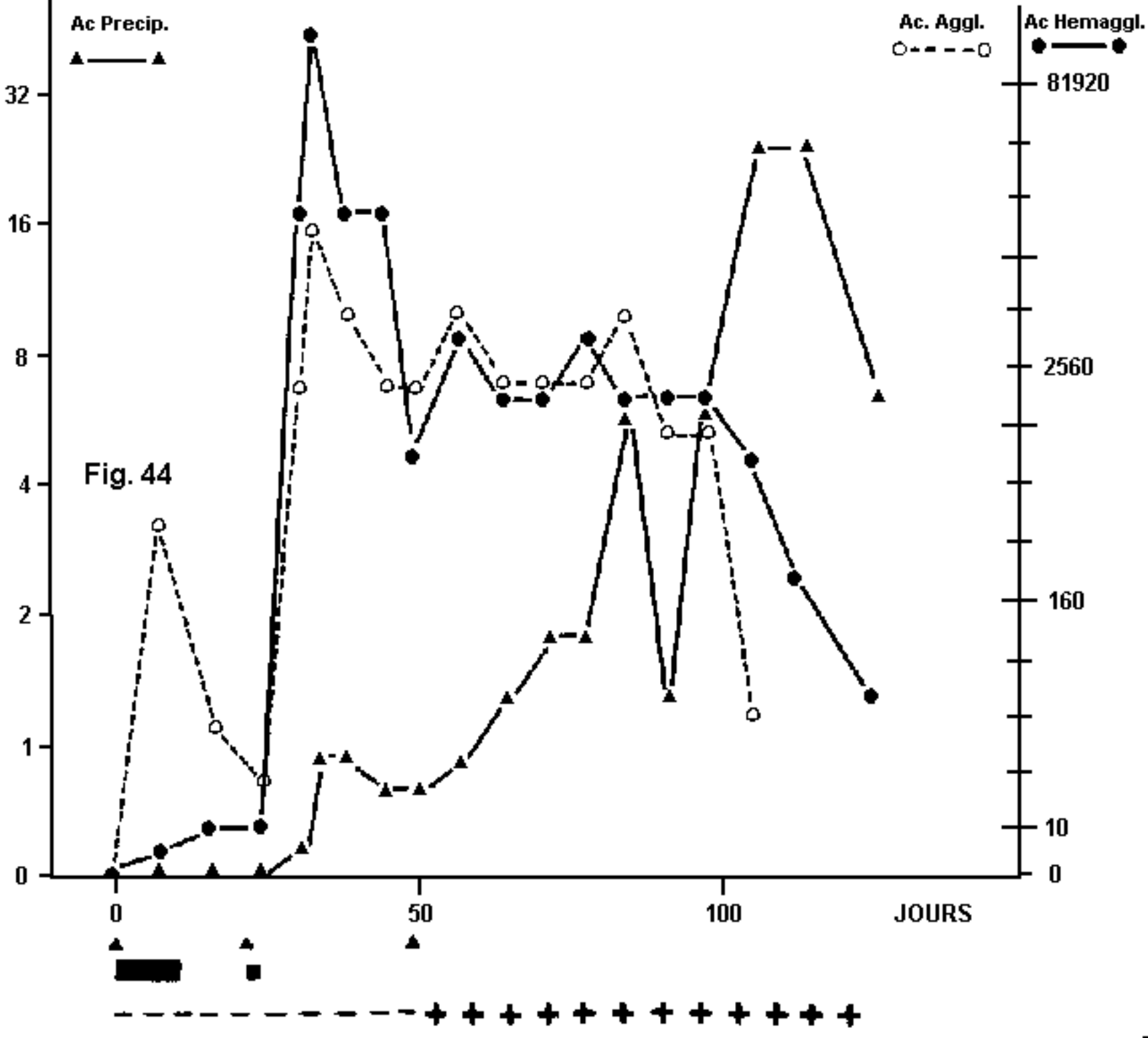
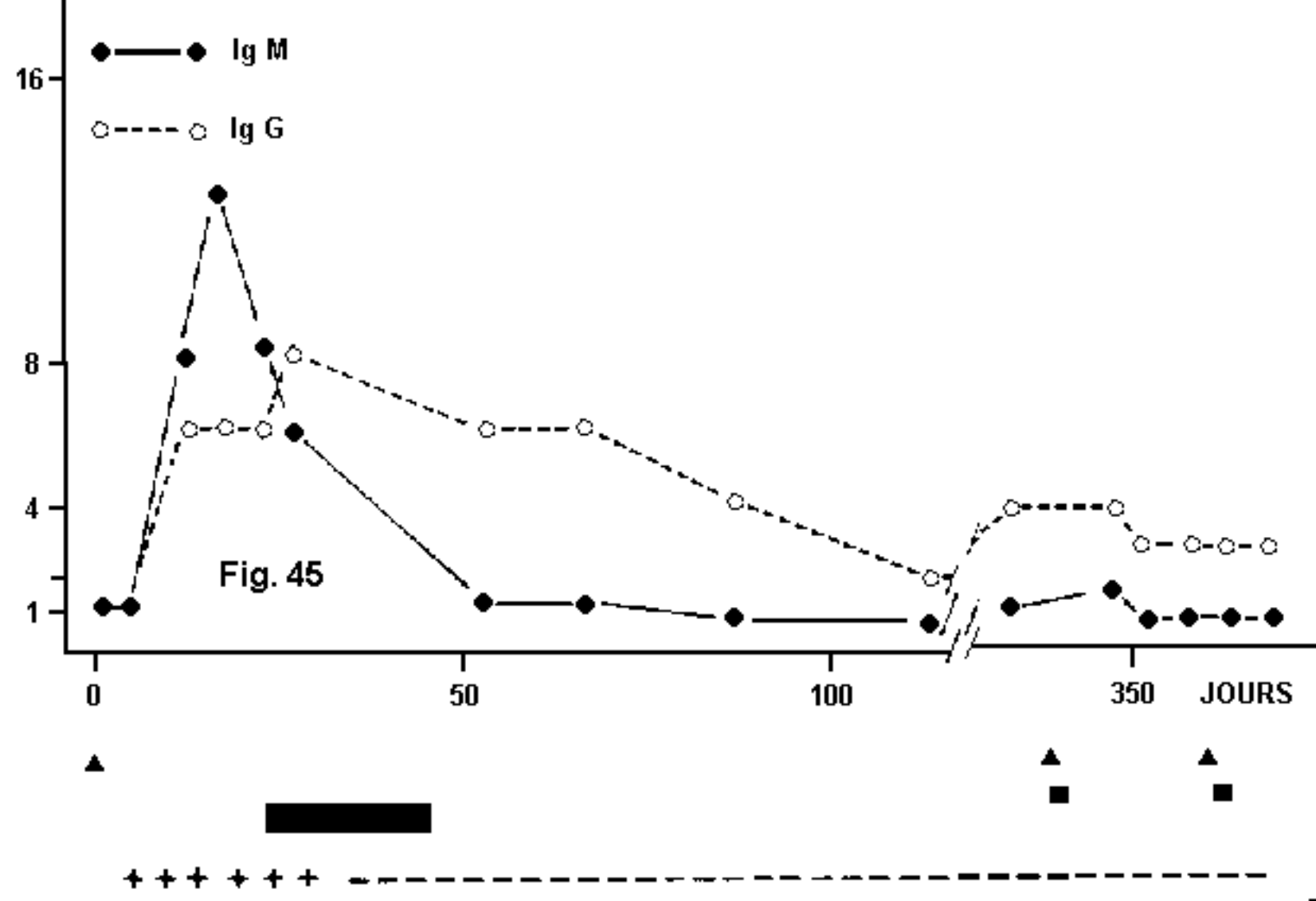
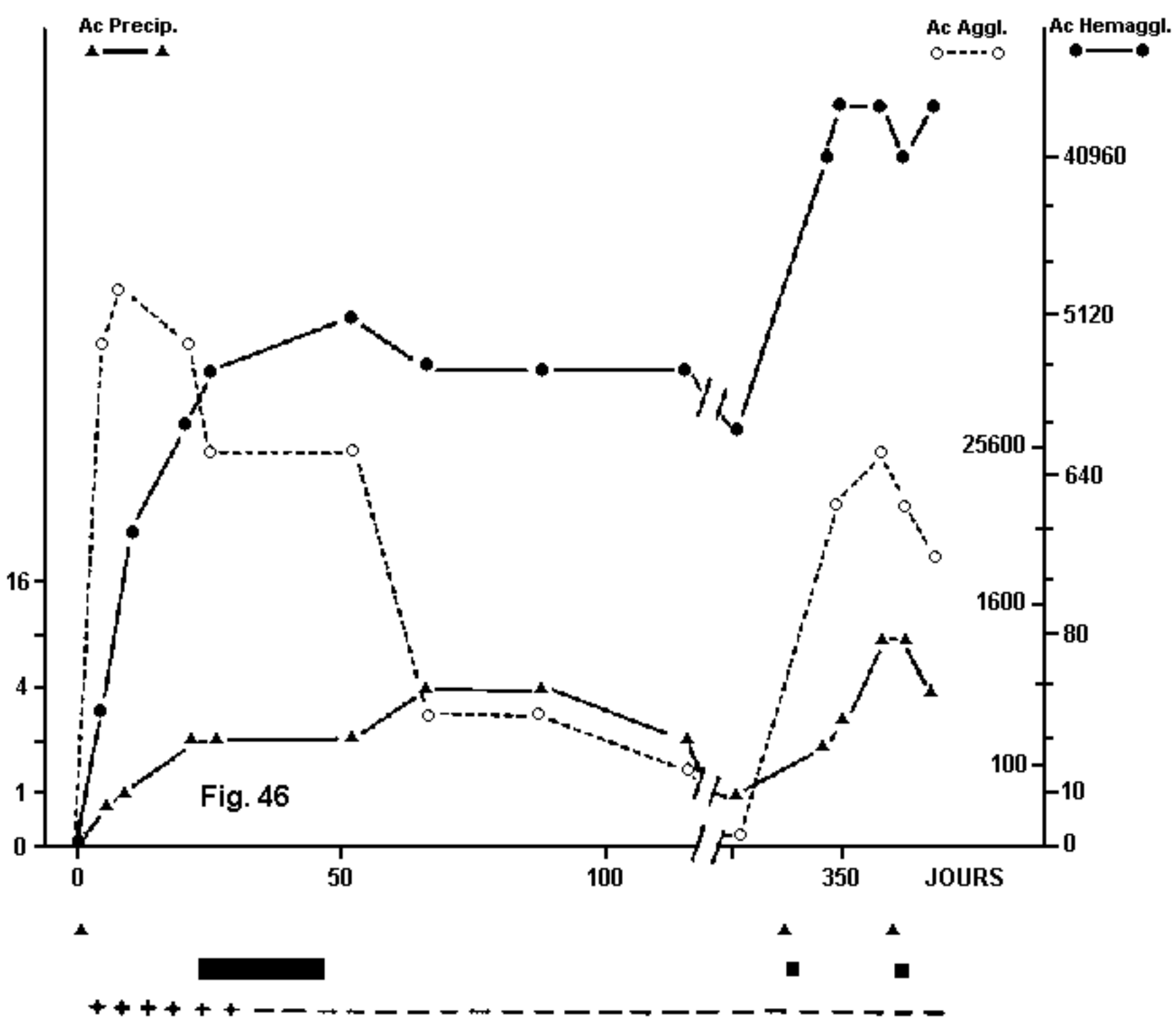

Fig. 42









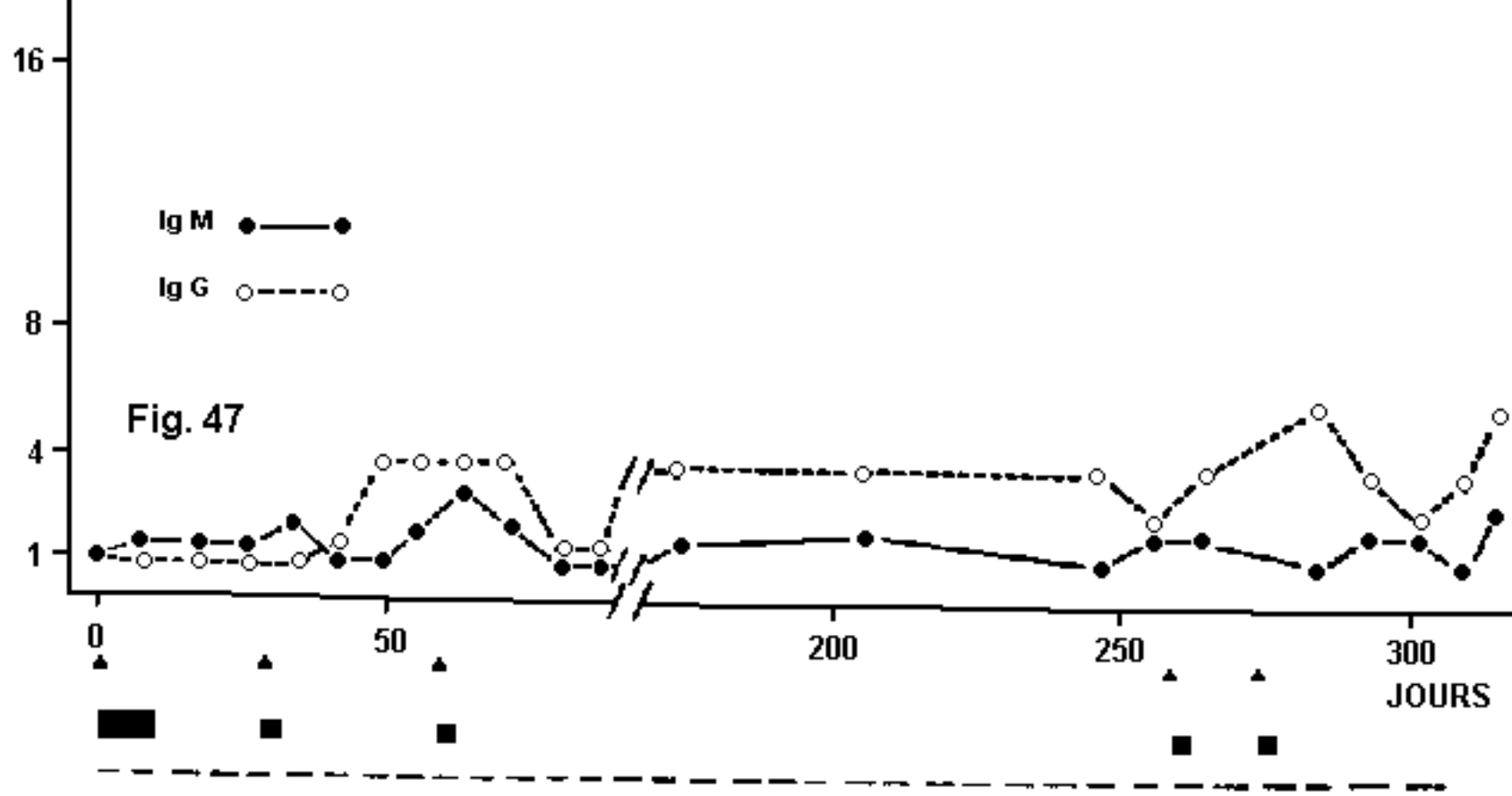

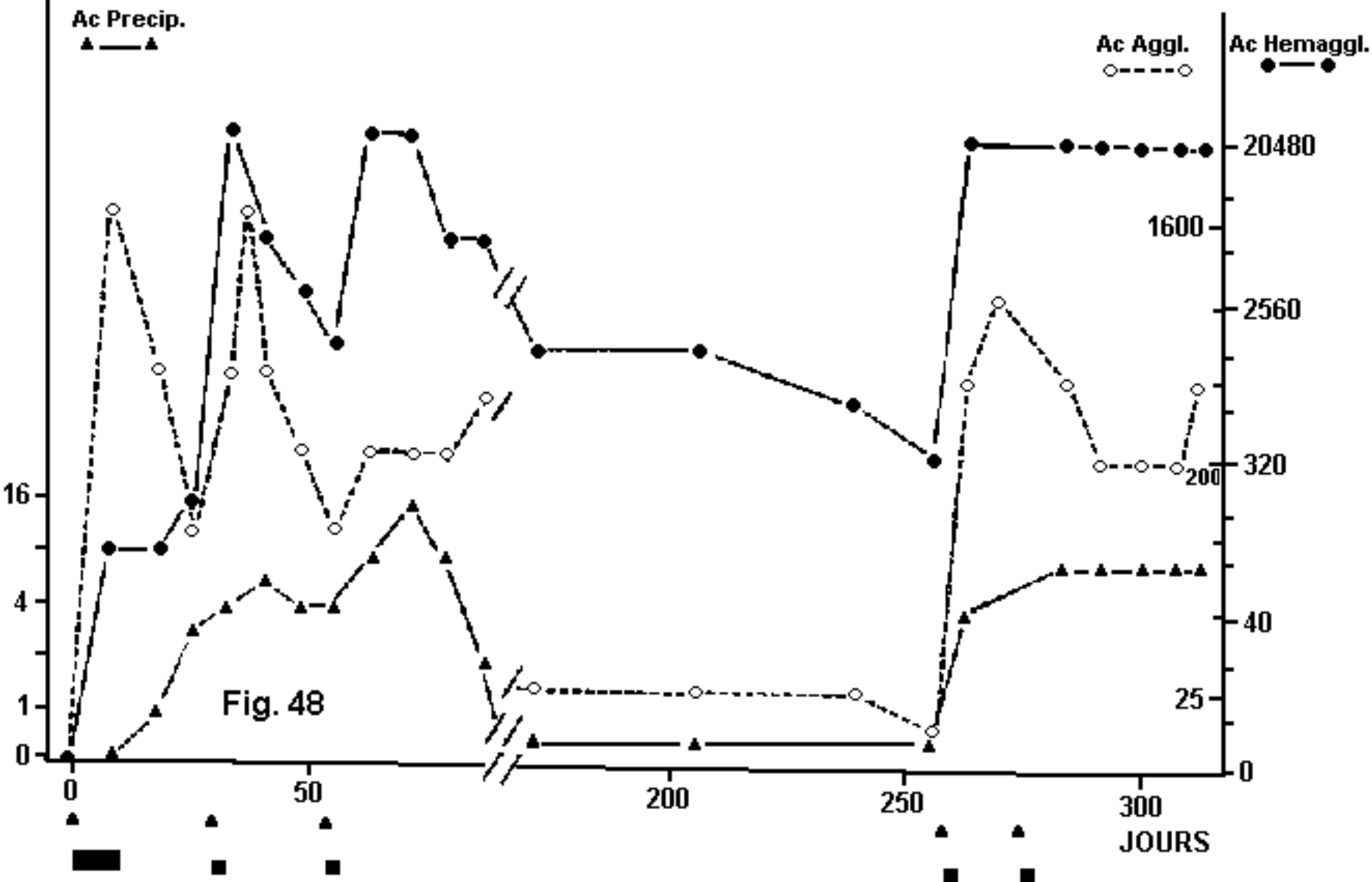
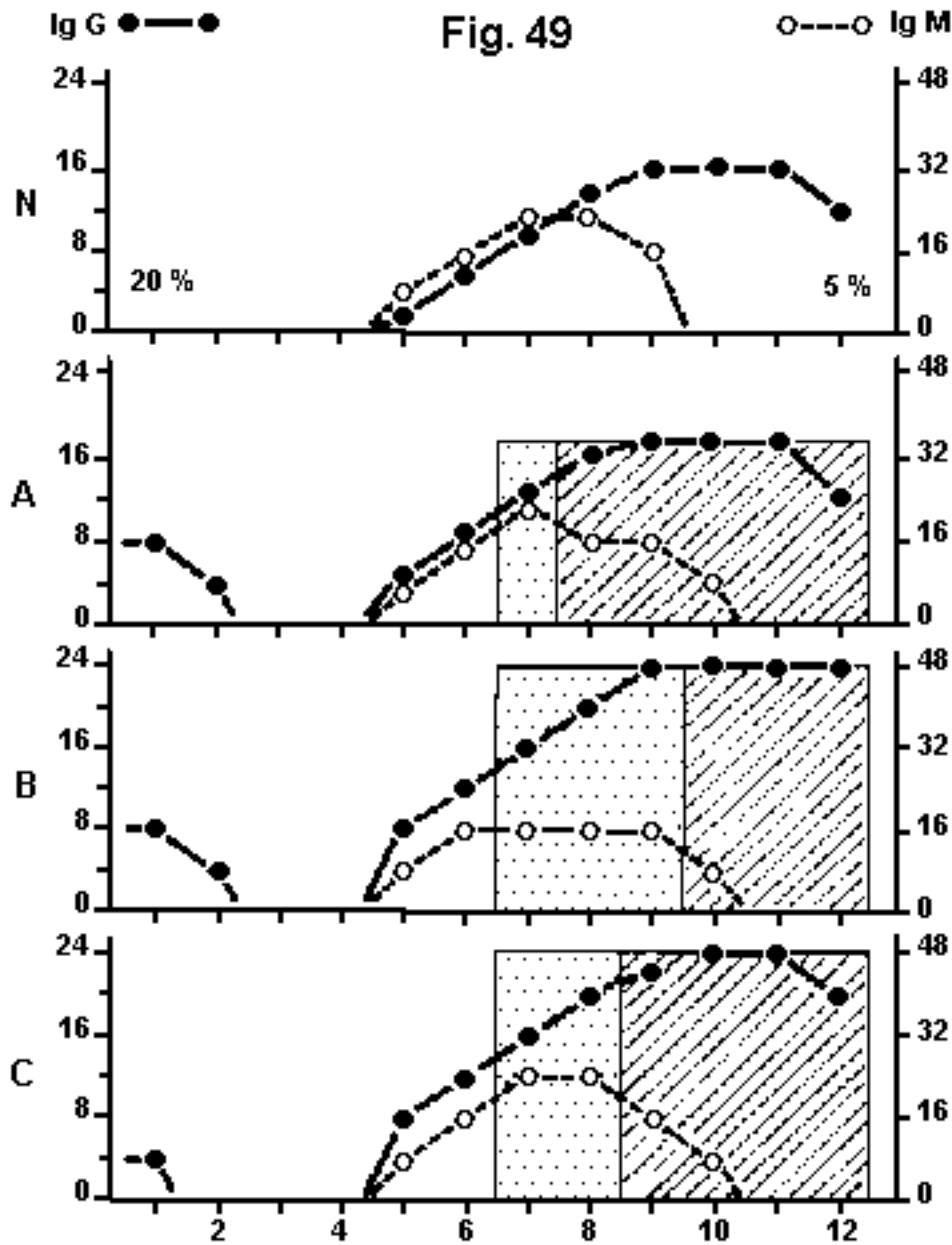
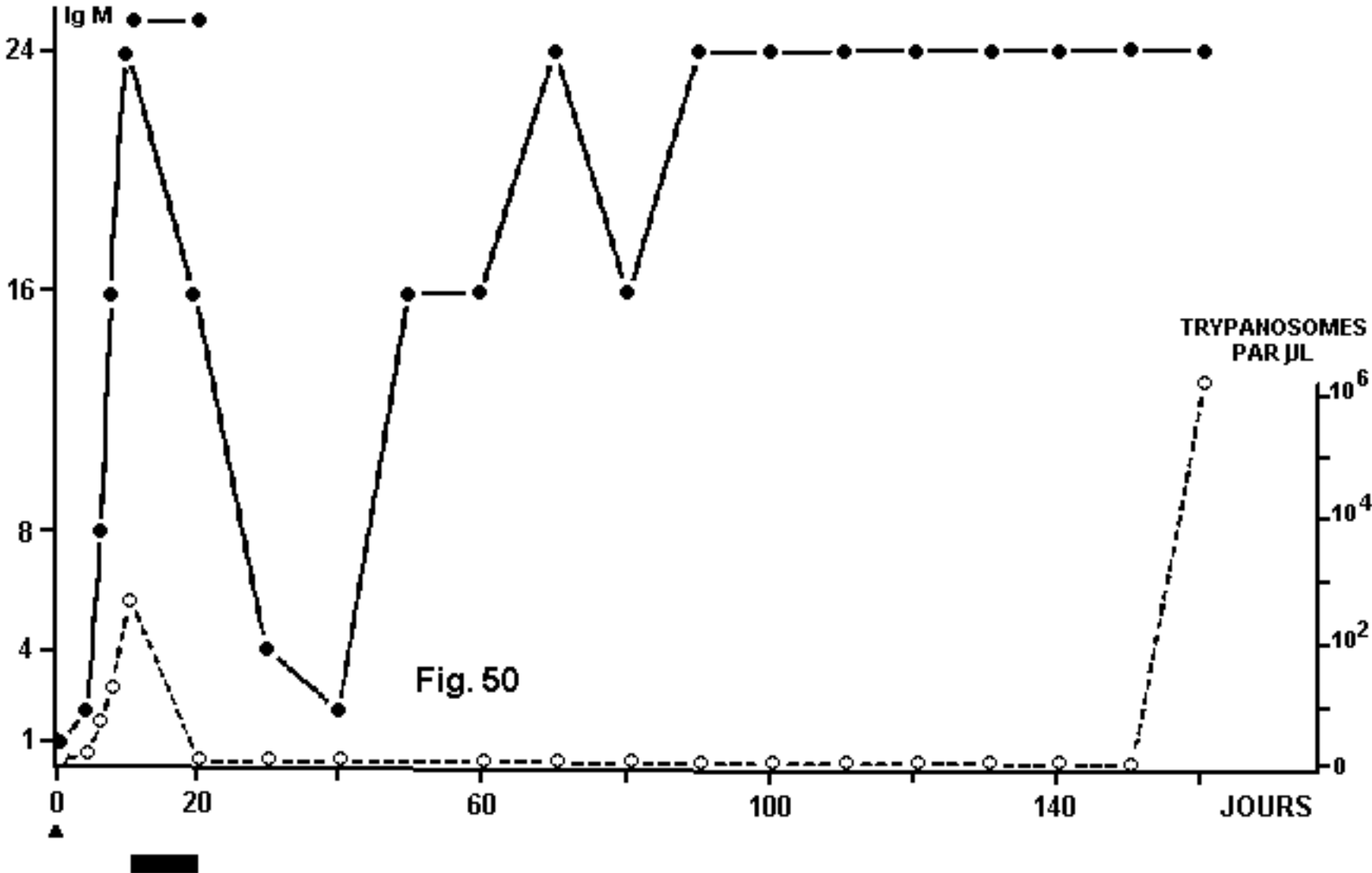
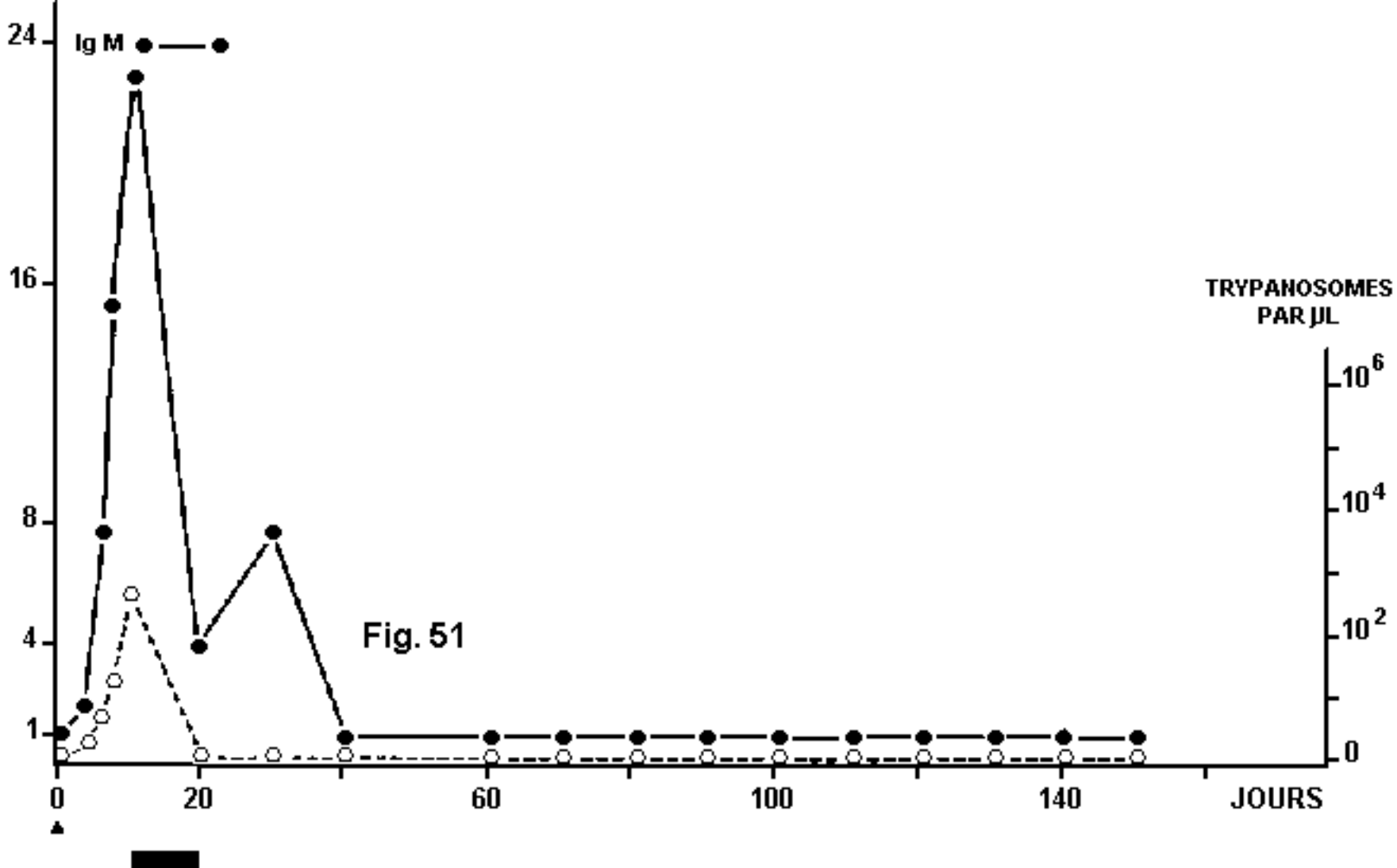



Fig. 49







○ --- ○ Témoins

● — ● Traités

